



X-ray and CT VOXLS 20 Series

Powerful, compact X-ray  
CT system with large  
inspection capacity and  
superior image quality for  
industrial and research  
applications.



# VERSATILE X-RAY AND CT VOXLS 20 SERIES

# Class-leading CT Inspection Envelope: Nikon's VOXLS 20 Series

The VOXLS 20 C 225 offers the largest CT scanning envelope in a system that fits through a standard double door, allowing for flexible integration into almost any quality laboratory or production environment. With its industry-leading inspection volume of 555 mm (Dia) x 759 mm (H) in a compact footprint of just 2,451 mm (L) x 1,173 mm (D), the VOXLS 20 Series delivers maximum capability in minimal space.

Built on Nikon's metrology-grade foundation, including granite base, rigid steel manipulator towers, and high-accuracy encoders and motors, the VOXLS 20 Series ensures the precision, reliability, and premium data quality for which the Nikon brand is known.

This versatile system features a dual-source configuration with motorized source switching, compatibility with all Nikon Scan Enhancement features, and it is equally at home in a laboratory setting or integrated into a production line.

The VOXLS 20 C 225 is ready to adapt to the evolving needs of high-end manufacturing businesses, providing unparalleled value per voxel in the market.



# Nikon's VOXLS 20 Series

## VERSATILE

The VOXLS 20 Series combines flexibility with power, allowing users to optimize configuration for their specific inspection needs. This adaptable system easily handles diverse applications, from precision electronics to complex castings.

### EXCEPTIONAL FLEXIBILITY

The system features **dual-source capabilities** with a 225 kV reflection and 160 kV transmission target source, allowing users to achieve high productivity and maximum resolution in one system. Its **motorized FID** optimizes magnification and flux for each unique sample, resulting in faster scan times or improved image quality. The **tilt stage** provides flexible positioning for challenging samples, enabling 2D Digital Radiography in hard-to-reach areas and **Tilted CT** scans on planar samples for maximum resolution and image clarity.



Motorized FID

### SUPERIOR SCAN COVERAGE

Envelope expansion is achieved through advanced **Scan Enhancement** features in the VOXLS 20 Series, including **Panel Shift CT**, which allows horizontal detector movement to capture wide samples in a single CT volume. **Helical CT** enables superior imaging of tall objects in a single acquisition process, eliminating cone beam artifacts and increasing resolution. **Offset CT** further enhances imaging by capturing objects wider than the detector itself, enabling higher magnification and revealing enhanced detail.

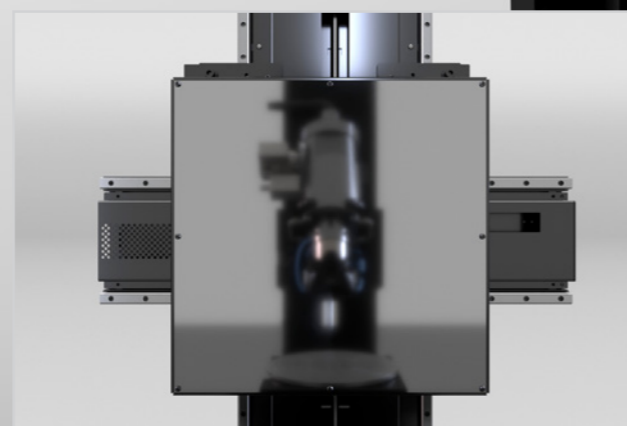

Panel Shift

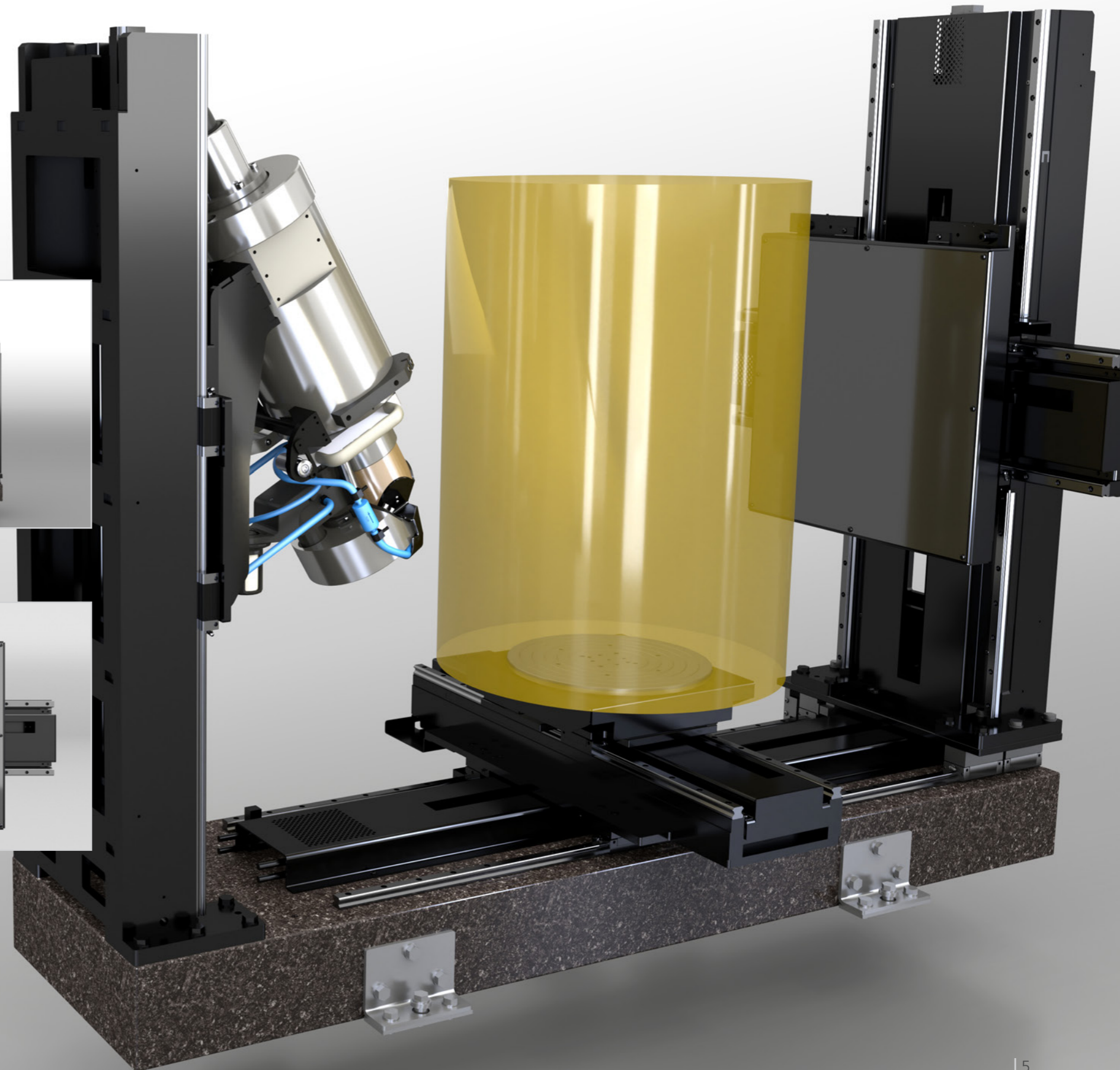

# Nikon's VOXLS 20 Series USER-FRIENDLY

The VOXLS 20 Series streamlines the inspection workflow with intuitive controls and thoughtful design elements that minimize setup time and maximize operator confidence, regardless of experience level.

## EFFORTLESS X-RAY SOURCE SET-UP

The system offers a **one-click source change** capability, allowing users to quickly and seamlessly switch between 160 kV and 225 kV sources with a simple mouse click. **Source Optimization** further enhances performance by simplifying filament setup and replacement, increasing filament lifetime, and ensuring optimal source performance. The integrated **Filter Changer** provides convenient on-the-fly filter switching, enabling users to maximize image quality across different material densities without the need to spend valuable time opening and closing the system door.

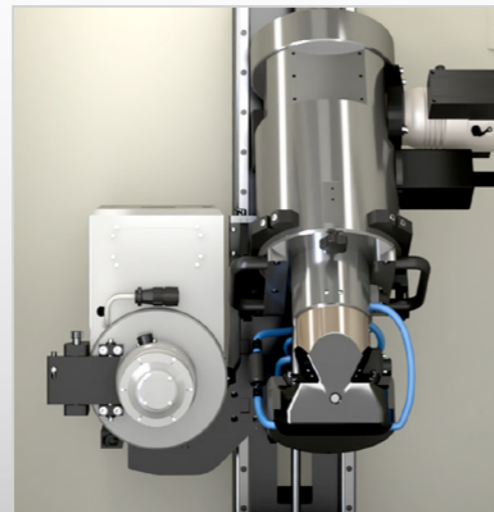

One-click source change

## OPERATOR-FOCUSED DOOR DESIGN

Operator convenience is prioritized through thoughtful design elements like the **rapid access door**, which opens in just 4 seconds, significantly reducing wait times and enhancing the overall user experience. The large **glass interlock door** provides an unobstructed, view of the scanning chamber, allowing operators to position samples with confidence and precision.



Unobstructed Visibility

LARGE GLASS INTERLOCK DOOR

HIGH VISIBILITY WARNING LIGHTS

4 SECOND DOORS



ERGO DESK

TOUCH SCREEN CONTROL PANEL

# Nikon's VOXLS 20 Series PREMIUM DATA QUALITY

The VOXLS 20 Series delivers exceptional image clarity and dimensional accuracy through Nikon's commitment to precision engineering and innovative development and integration of advanced imaging technologies.

## METROLOGY-GRADE SYSTEM BY DESIGN

The system is engineered with a metrology-grade granite base and steel towers that provide exceptional mechanical and thermal stability. Combined with precision motors and linear encoders, this foundation ensures exact part positioning and repeatable measurements for high-quality imaging across all industrial inspection applications.

## HIGHER RESOLUTION WHEN YOU NEED IT

The VOXLS 20 Series delivers superior data quality through advanced Scan Enhancement features, including **Pixel Split CT** technology that quadruples pixel count for increased resolution and **Tilted CT**, which allows tilting the axis of rotation to maximize magnification and resolution on planar or high aspect ratio objects with a small region of interest.

Scan Enhancement Features

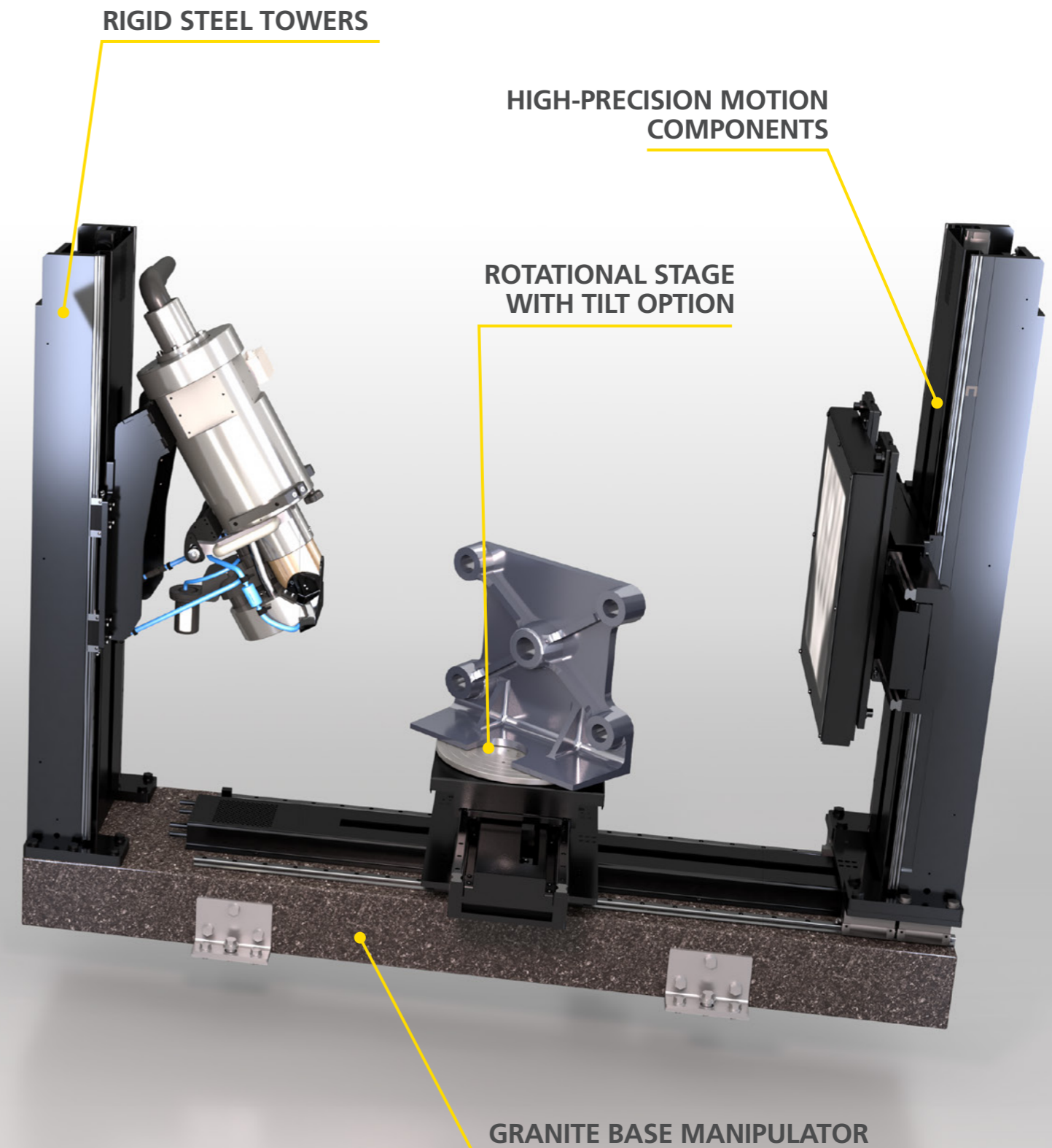
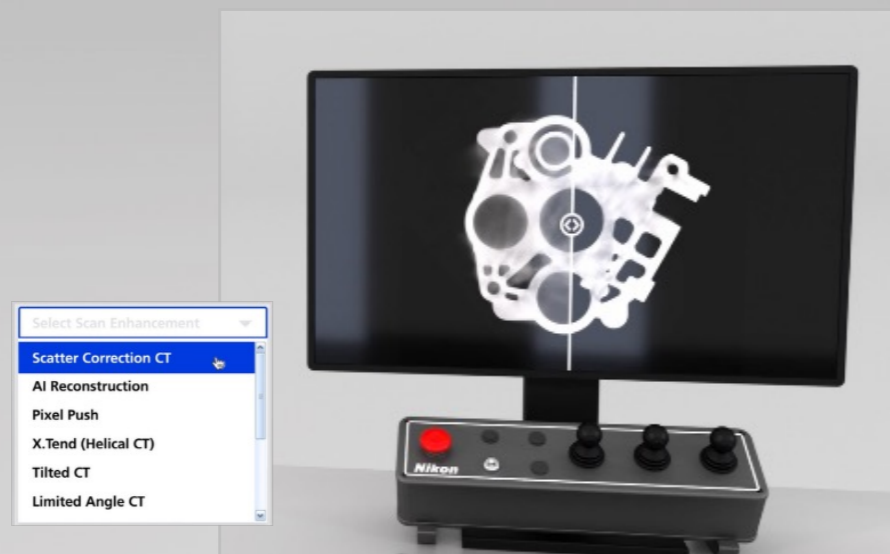

# Nikon's VOXLS 20 Series PRODUCTIVE

The VOXLS 20 Series maximizes inspection throughput without sacrificing quality, enabling faster decisions and higher productivity in research and production environments.

## PUSHING SCAN TIME LIMITS

The system enhances productivity through innovative Scan Enhancement features that optimize scan speed and image quality.

**AI Reconstruction** technology intelligently filters noise and artifacts, improving image clarity while allowing faster scan times.

The **Half.Turn CT** feature further boosts throughput by generating high-quality scan data by rotating the sample through just over 180 degrees instead of the full 360 degrees, significantly decreasing overall scanning time.

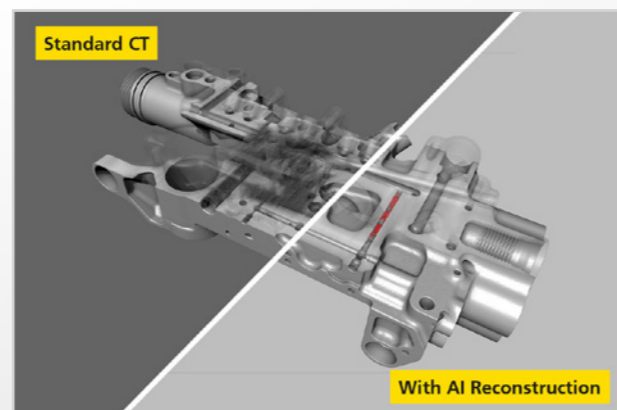

AI Reconstruction

## AUTOMATION READY

Increase user efficiency and independence with easy-to-use **scan profiles** and batch scanning. These profiles can be recalled to load all acquisition, reconstruction and analysis parameters of a sample, ensuring repeatability of the complete inspection process, especially during operator and shift changes.



Autoloader

For advanced automation, Nikon's OPC UA interface can be used to seamlessly integrate an **Autoloader** for unattended pick-and-place inspection of multiple samples or **robotic** loading functionality for fully automated, continuous inspection to support real-time process optimization and zero-defect manufacturing.



# Nikon X-ray Sources

Nikon Metrology X-ray sources are at the heart of our technology and have been designed and manufactured in-house at our UK factory since 1987. All our sources are of microfocus open-tube design, which provides micron-level resolution, exceptional image quality, and a low cost of ownership.

## OPTIMAL SOURCE PERFORMANCE WITHOUT WORRIES

Source Optimization transforms X-ray source management for the 225 kV source by making critical processes operator-independent and more reliable. This innovative technology automatically optimizes source performance after each filament change, effectively deskilling the entire setup process. The algorithm standardizes filament configuration without requiring specialized knowledge, eliminating operator variance that traditionally affects image quality. This approach simplifies maintenance procedures while delivering more consistent and repeatable imaging results across different applications, regardless of who operates the system.

By continuously monitoring source performance and providing intelligent tracking of key parameters, Source Optimization extends filament lifetime. This technology extends the operational life of the filament, decreasing system downtime for maintenance while increasing overall productivity.

## 160 KV TRANSMISSION TARGET

Nikon's highest resolution source enables sub-micron feature recognition and a maximum energy of 160 kV and 20 W power, which is ideal for high-resolution CT of small objects. The integrated voltage generator eliminates the need for a high-voltage cable assembly, resulting in lower maintenance costs and higher reliability.

## 225 KV ROTATING TARGET

Exclusive technology spins the target at high speed in combination with advanced liquid cooling to dissipate heat, enabling continuous operation at 450 W full power. This innovation significantly boosts X-ray photon flux while maintaining a small, consistent focal spot, resulting in faster scan times and a better signal-to-noise ratio, all without sacrificing resolution.

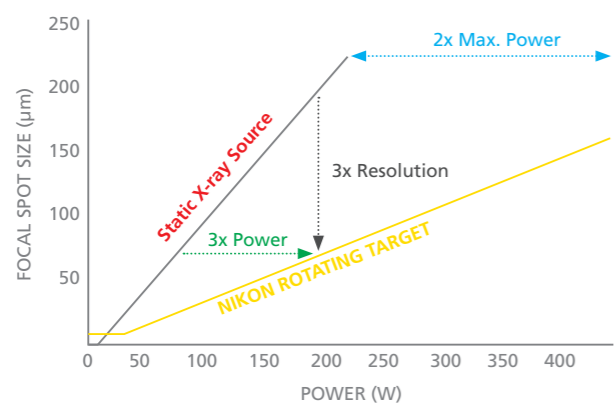

225 kV Rotating Target 2.0



# Expand capabilities with a full suite of Scan Enhancements

## RESOLUTION IMPROVEMENT

While standard CT reveals internal structures invisible to conventional inspection methods, some applications demand even greater detail. The VOXLS 20 Series offers specialized techniques to significantly increase resolution for critical feature analysis and detailed examination of specific regions of interest.

### Tilted CT

maximizes magnification for planar samples and small features

### Limited Angle CT

focuses resolution where it matters most

### Pixel Split CT

quadruples effective pixel count for ultra-high-resolution imaging

### Offset.CT

achieves higher magnification across wider samples

### X.Tend Helical CT

improve resolution uniformity throughout tall samples

## DATA QUALITY ENHANCEMENT

Even the best CT scans can be affected by image artifacts that obscure critical features and hinder accurate analysis. The VOXLS 20 Series includes advanced tools that minimize noise, scatter, beam hardening, and cone beam artifacts to deliver exceptional image clarity and precise surface determination.

### Scatter Correction CT

reduces scatter-induced artifacts for cleaner images

### Dual.Material CT

optimizes reconstruction of multi-material components

### AI Reconstruction

applies machine learning to enhance image quality

### X.Tend Helical CT

eliminates cone beam artifacts for improved data integrity

## SCAN VOLUME EXTENSION

The VOXLS 20 C 225's sophisticated 9-axis manipulator expands inspection possibilities beyond traditional circular CT, allowing you to examine samples that would otherwise be too large. These powerful enhancements extend your scanning envelope both vertically and horizontally, accommodating parts up to 555 mm in diameter and 759 mm in height.

### X.Tend Helical CT

seamlessly scan tall objects in a single continuous acquisition.

### Offset.CT

extends the effective scanning area for wider components

### Panel Shift CT

captures oversized parts in a single CT volume

## PRODUCTIVITY BOOST

When inspection speed is critical—whether for first-article inspection, process control, or failure analysis—the VOXLS 20 Series delivers with tools that dramatically reduce scan times without compromising data quality, ensuring reliable analysis with maximum efficiency.

### Half.Turn CT

cuts acquisition time nearly in half while maintaining image quality

### AI Reconstruction

generates high-quality reconstructions from shorter scan times

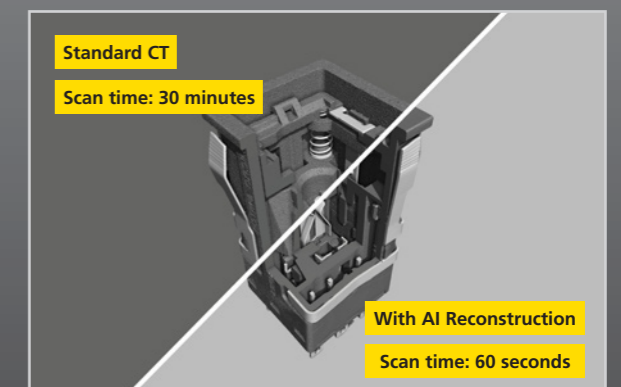
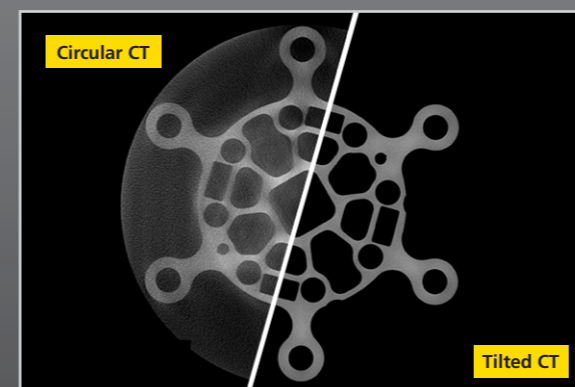



# Applications

The VOXLS 20 Series excels across diverse industries and applications, providing non-destructive testing, internal visualization, and precise measurement where traditional inspection methods fall short. Its versatility makes it ideal for both research and production quality control.



## AEROSPACE

Inspect critical components like turbine blades, composites, and lightweight structures with high resolution to ensure safety and performance in demanding aerospace applications.



## BATTERIES

Perform comprehensive quality analysis of cells to identify critical defects such as electrode misalignment, electrolyte distribution issues, and internal shorting risks.

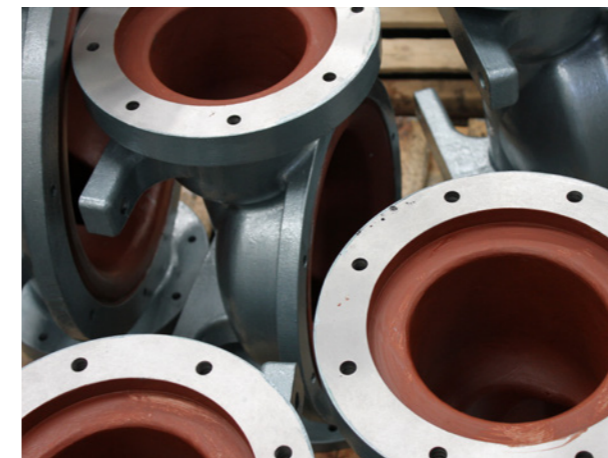

## CASTINGS

Detect internal porosity, inclusions, and structural issues in light metal castings with clarity that traditional inspection methods cannot match.

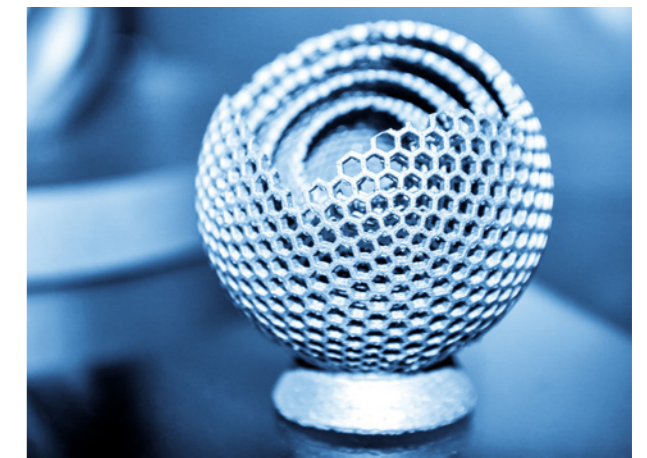

## ADDITIVE MANUFACTURING

Validate internal structures, identify porosity, and verify dimensional accuracy of complex parts created through additive manufacturing processes.



## AUTOMOTIVE

Evaluate castings, electrical components, composites, and assemblies quickly and precisely to support automotive quality control and development.

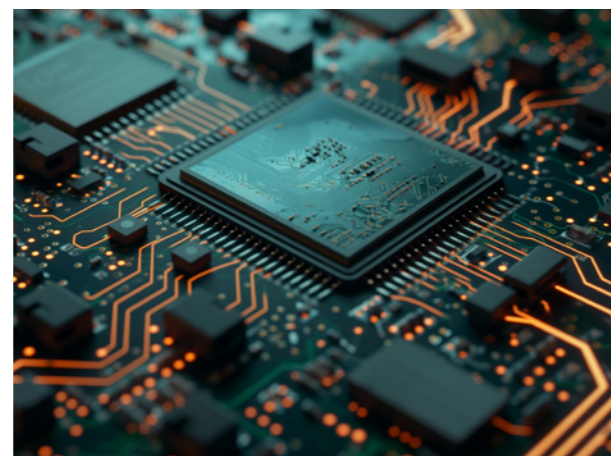

## ELECTRONICS

Examine circuit boards, electronic components, and semiconductor packages to identify defects, verify assembly, and ensure product quality.



## SPACE

Support critical defense applications with non-destructive testing capabilities that ensure component integrity and performance reliability.



## RESEARCH & UNIVERSITIES

Enable cutting-edge research with high-resolution imaging capabilities that reveal internal structures in biological specimens, materials, and engineering samples.

# Full range of Nikon X-ray CT Systems

Nikon offers a comprehensive range of X-ray and CT systems to meet diverse industry inspection needs. From compact, high-resolution systems for small components to large-envelope solutions for industrial parts, each system delivers the precision, reliability, and image quality that Nikon is known for worldwide.



XT V 160

XT H 225

XT H 225 ST 2x

VOXLS 20 Series



VOXLS 30 Series

VOXLS 40 Series

Configurable Large Envelope

# Build ROI or supplement your in-house capabilities with **X-ray Inspection Services**

Nikon's X-ray inspection services provide access to advanced CT technology and expert analysis without capital investment. Whether you need occasional inspections or are evaluating technology for future purchase, our certified technicians deliver fast, precise results to support your quality control and development needs.

- 1 CONTACT US**  
Whether ONE part or THOUSANDS, contact us to discuss your needs, and we will develop a nondestructive solution tailored to you. 
- 2 SEND PARTS**  
Send your parts to one of our many inspection labs throughout the world. 
- 3 WE SCAN**  
Our experts will optimize the imaging technique to meet or exceed your project requirements. 
- 4 YOU GET RESULTS**  
With industry-leading turnaround times and expedited options, we deliver the results you need to keep your business moving. 

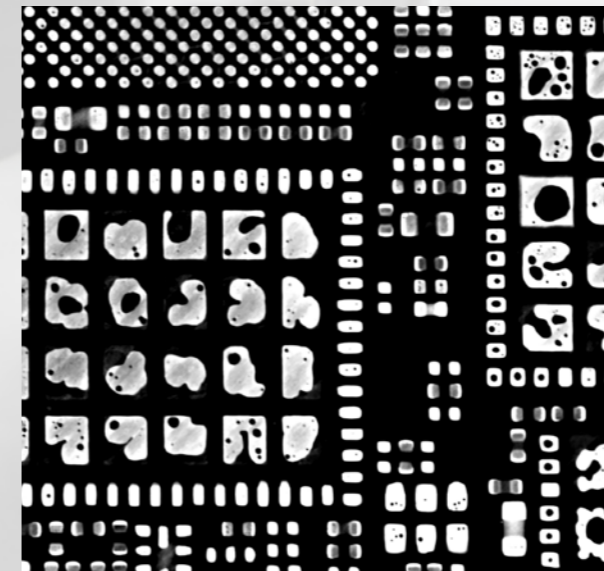

Single Layer Inspection of Multilayer Circuit Board



Component Segmentation of Heated Steering Wheel

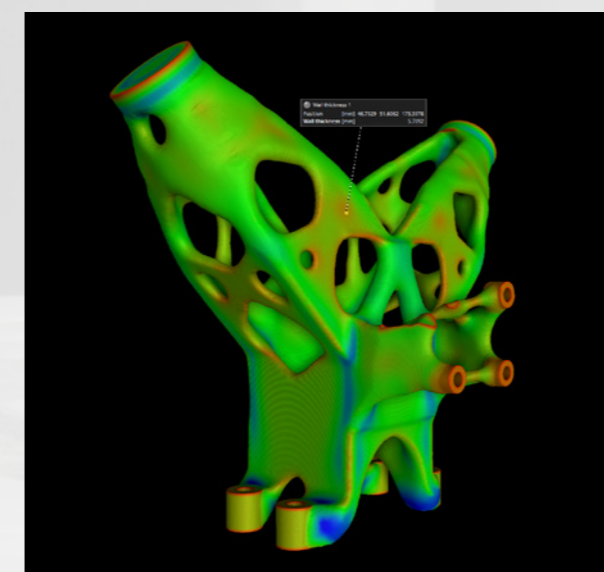

Wall Thickness Analysis of 3D Printed Bracket

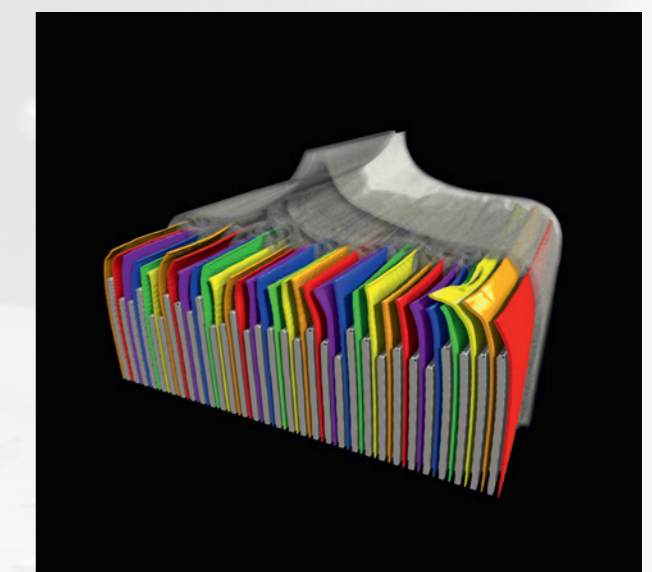

Overhang Analysis on Lithium-Ion Battery Pouch Cell

# Support you can count on

Nikon's commitment to customer success extends beyond equipment delivery with comprehensive support options that ensure your system performs optimally throughout its lifecycle. Our global team of trained service engineers provides responsive assistance when and where you need it.

## MAINTENANCE PROGRAMS

Preventive maintenance by Nikon-trained service engineers keeps your equipment at peak performance, reducing unscheduled downtime and maximizing inspection productivity.

## REPAIR NETWORK

Our global network of technicians provides prompt, high-quality repairs using original parts to restore your system to optimal condition with minimal disruption.

## TRAINING

We offer comprehensive training programs tailored to different skill levels, delivered at our facilities or yours, ensuring your team can maximize the capabilities of your Nikon system.

## UPGRADES

From detector enhancements and X-ray source upgrades to the latest analysis tools and reconstruction algorithms, Nikon ensures your investment delivers optimal performance and expanded capabilities throughout its service life.



# Specifications

<b>Sources</b>	225 kV Microfocus source with Static or Rotating Reflection Target
	Optional 160 kV source with Transmission Target
<b>Max. Scan Volume</b>	555 x 759 mm (Ø x H)
<b>Max. Sample size</b>	750 x 1,297 mm (Ø x H)
<b>Max. Sample Weight</b>	90 kg central load
<b>System Dimensions</b>	2,451 x 1,173 x 2,018 mm (L x D x H)
<b>System Weight</b>	4,800 kg

VOXLS 20 Series\_XR-VX20-2506EN – Copyright Nikon Metrology NV 2023. All rights reserved. The materials presented here are summary in nature, subject to change, and intended for general information only.



## NIKON CORPORATION

1-5-20, Nishioji, Shinagawa-ku, Tokyo 140-8601, Japan  
Tel: +81 3 6743 5742  
<https://industry.nikon.com>

### NIKON METROLOGY EUROPE NV

Interleuvenlaan 86  
3001 Leuven, Belgium  
Tel: +32 16 74 01 01  
Sales.NM@nikon.com

### NIKON METROLOGY UK LTD.

UNITED KINGDOM Tel: +44 1332 811 349  
Sales.UK.NM@nikon.com

### NIKON METROLOGY SARL

FRANCE Tel: +33 1 60 86 09 76  
Sales.France.NM@nikon.com

### NIKON METROLOGY GMBH

GERMANY Tel: +49 211 4544 6951  
Sales.Germany.NM@nikon.com

### NIKON METROLOGY, INC.

12701 Grand River Road, Brighton,  
MI 48116 U.S.A.  
Tel: +1 810 220 4360  
Sales.NM-US@nikon.com

### NIKON METROLOGY - MÉXICO

Sales.NM-US@nikon.com

### NIKON PRECISION (SHANGHAI) CO., LTD.

CHINA Tel: +86 21 6841 2050 (Shanghai branch)  
CHINA Tel: +86 10 5831 2028 (Beijing branch)  
CHINA Tel: +86 20 3882 0551 (Guangzhou branch)  
Web.Nis@nikon.com

### NIKON INSTRUMENTS KOREA CO. LTD.

KOREA Tel: +82 2 6288 1900  
NIK.Sales@nikon.com

### NIKON SINGAPORE PTE. LTD.

SINGAPORE Tel: +65 6559 3651  
NSG.Industrial-sales@nikon.com

### PT. NIKON INDONESIA

INDONESIA Tel: +62 213 873 5005  
PTN.Instruments@nikon.com

### NIKON SALES (THAILAND) CO., LTD.

THAILAND Tel: +66 2633 5100  
NST.Inst@nikon.com

ISO 14001 Certified  
for NIKON CORPORATION

ISO 9001 Certified  
for NIKON CORPORATION  
Industrial Solutions Business Unit