



Industrial X-ray  
and CT



# ADVANCED INDUSTRIAL X-RAY AND CT XT H Series

# Nikon's XT H Series



X-ray computed tomography (CT) has been used for many years in laboratories to non-destructively inspect the interiors of samples such as fossils and ancient artifacts. There are compelling reasons for this academic and R&D interest: CT can detect voids, cracks, burrs, and other imperfections inside parts and assemblies without destruction.

Now, this valuable technology is increasingly being introduced on the factory floor for quality control and metrology. And by combining specialized hardware with innovative software, Nikon's XT H Series delivers the efficiency, reliability, and accuracy required for production-level applications.

The adaptability of the XT H Series stems from its configurable, state-of-the-art components, including X-ray targets that are interchangeable to optimize for different materials. These customizable systems can be adapted to inspect a broad range of sample types and sizes, tackling diverse industrial inspection challenges in the workplace.



# A wide range of applications



Connector wiring



Turbocharger cast housing

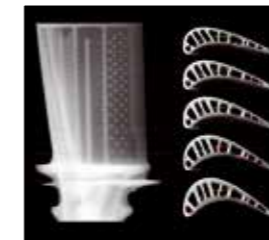

Turbine blade



Battery

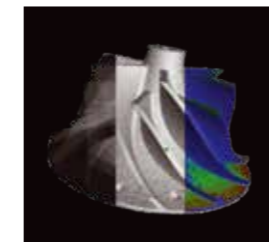

3D printed impeller



Sectioned light bulb

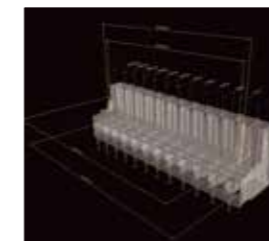

Plastic connector



Medical injector

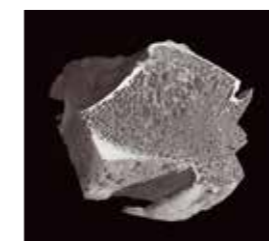

Femur bone

Anywhere the internal structure matters, X-ray and CT technology serves as an efficient tool to provide valuable information. Detailed capture and measurement of internal features is often vital for quality control, failure analysis and material research across various industries.

- Fault detection and failure analysis
- Assembly inspection of complex mechanisms
- Dimensional measurement of internal components
- Part-to-CAD comparison
- Advanced material research
- Analysis of the biological structures
- Digital archiving of models

## AUTOMOTIVE

- Electrical connectors
- Injection nozzles
- Sensors (e.g. Lambda sensor)
- LED light pipes
- Small high-pressure die cast parts
- DPF (Diesel Particulate Filters)

## AEROSPACE

- Wax turbine blades
- Titanium turbine blades
- Crack analysis in components
- Weld analysis

## PLASTIC INJECTION MOLDING

- Complex plastic components (e.g. fan)
- Soft, translucent materials where tactile or optical is no option
- Ultrasonic welding of plastic parts

## PHARMACEUTICAL/MEDICAL

- Medicine dispensers
- Small medical devices (instruments, stents, pacemaker, etc)
- Small plastic or composite parts
- Bone structures
- Implants (dental, hip, knee, skull)

## RESEARCH

- Material verification and analysis (e.g. structure, porosity, defects)
- Paleontology (e.g. bones, skulls, fossils)
- Geology and soil science
- Archeology
- Renewable energy (batteries, solar cells, etc.)

# X-ray sources

## IN-HOUSE DESIGN AND BUILD

Nikon Metrology X-ray sources are at the heart of our technology and have been designed and manufactured in-house from 1987 to this day; offering decades of knowledge. Control over the X-ray source technology allows Nikon Metrology to quickly move with the market and develop complete and innovative solutions to the application demand. All sources are open-tube giving a low cost of ownership and range from low (180) to medium (225) kV, all with micron-level resolution.

One X-ray tube, four target modules, limitless applications



### 180 kV TRANSMISSION TARGET

- Liquid-cooled Transmission Target
- Sub-micron feature recognition
- High resolution up to 180 kV
- Perfect for high resolution CT of small samples



### 225 kV REFLECTION TARGET

- Liquid-cooled Reflection Target
- Spot size down to 3 micron
- High resolution up to 225 kV
- Outstanding image quality and high resolution across a broad sample range



### 225 kV ROTATING TARGET 2.0

- Liquid-cooled Rotating Reflection Target
- 3x higher resolution for the same power as static target
- 3x higher power for the same resolution as static target
- Resulting in significantly faster scan times
- No cool-down periods; continuous operation up to a stunning 450 Watts power



### 225 kV MULTI-METAL REFLECTION TARGET

- Industry unique multi-metal target
- Optimize the X-ray profile generated
- Change metals without breaking vacuum
- Unrivalled flexibility for complex applications
- Versatility to enhance image contrast, perfect for materials research and more

# XT H 225



Detailed capture and measurement of internal component and assembly features is often vital for quality control, failure analysis and material research. The entry-level versatile XT H 225 system offers a microfocus X-ray source, an inspection volume to accommodate small to medium sized parts and high image resolution. Ready for ultrafast CT reconstruction, the XT H 225 covers a wide range of applications, including the inspection of plastic parts, small castings and complex mechanisms as well as researching materials and natural specimens.

## EASY OPERATION

Users are operational with the system within a few days of training. A CT wizard guides operators through the data acquisition process. Customizable macros automate the measurement workflow, and tight integration with industry-standard Volume Graphics software, streamline the decision making process.

## FLEXIBILITY IN CT

Specific applications require more detailed images or higher accuracy. The XT H 225 can be configured with different flat panels or source configuration (reflection/ transmission target) to adapt resolution to the specimen's needs: full part in coarse resolution and high resolution in a desired region of interest. A small spot size and a high-resolution flat panel create sharp images.

## LOW COST OF OWNERSHIP

Regardless of the target of choice, the XT H 225 system uses an open-tube X-ray source that guarantees a lower cost-of-ownership. The open X-ray tube allows for local maintenance of internal tube components rather than whole tube replacements. The XT H 225 system is self-contained and quick to install. No special floor treatments are required.

## WITH ALL NIKON METROLOGY CT SYSTEMS YOU CAN

- Verify complex internal structures
- Isolate and inspect included components
- Measure internal dimensions without sectioning the sample
- Automatically detect and measure internal voids/volumes
- Reveal internal and external surfaces with ease
- Reduce total inspection time
- Reduce number of iterations to fine-tune (pre-) production parameters

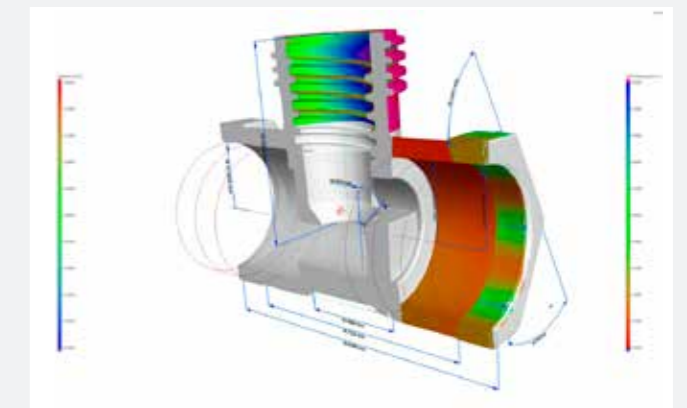

# XT H 225 ST 2x

The XT H 225 ST 2x system is ideally suited to a wide range of materials and sample sizes. The system can be configured with a range of industry-leading flat panel detectors, up to 2,880 x 2,880, 150 µm pixels, to best suit the user application.

Tools for increasing scan speed, prolonging system uptime and maintaining measurement accuracy, when combined with the interchangeable X-ray targets and motorized FID, provide a flexible tool for Quality Control laboratories, Production facilities, Research and Development departments and academia.



# MCT225

Dimensional inspection using industrial CT has many advantages, as all internal dimensions are measured without destroying the part. Metrology CT is possible by calibrating scans with reference measurements or using a metrology grade system.

The MCT225 is pre-calibrated using accuracy standards by VDI/VDE 2630 guidelines for Computed Tomography in dimensional measurement. Several key metrology features enable an impressive absolute accuracy specification of 9+L/50µm combined with long-term stability.



## AVAILABILITY AND PRODUCTIVITY

Auto.Filament Control intelligently manages the X-ray source to double the lifetime of the filament without relying on long-life filaments that would reduce the high-resolution micro-focus nature of the source. Less frequent changing of the filament means the system is available more often.

## MOTORIZED FID

The XT H 225 ST 2x has motorized FID (Focus to Imager Distance) adjustment, so the user can effortlessly change the distance between the X-ray source and detector. A shorter FID provides faster scan times for a given resolution or, alternatively, a higher signal-to-noise ratio for enhanced image quality.

## UNRIVALLED FLEXIBILITY

With four X-ray target heads, unique flexibility is achieved from a single 225 kV microfocus source. To optimize system performance, all targets are interchangeable by the user, quickly and effortlessly. The additional cost of buying and maintaining a second source tube and accessories is therefore avoided.

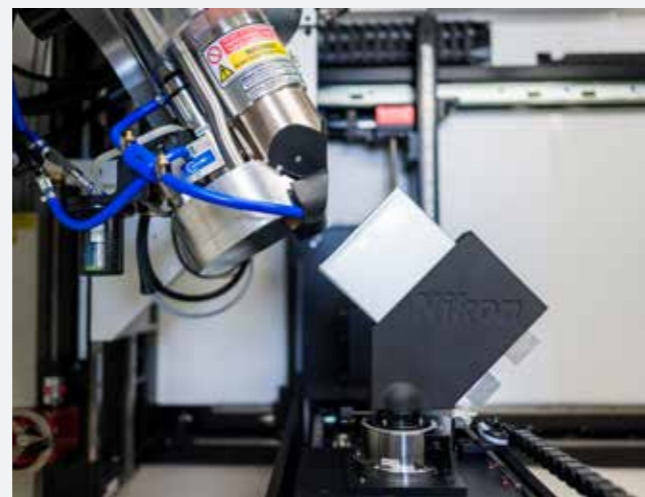
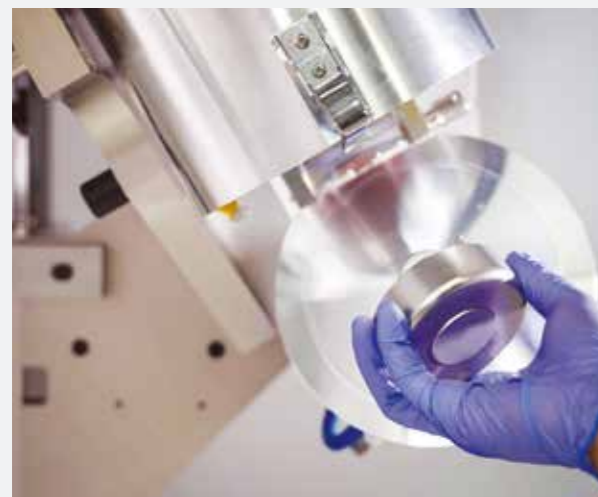

## ABSOLUTE ACCURACY

MCT225 is pre-calibrated using accuracy standards recognized by the National Physical Laboratory (NPL), the UK's National Metrology Institute (NMI), and verified using VDI/VDE 2630 guidelines for Computed Tomography in Dimensional Measurement. Absolute Accuracy guarantees measurement accuracy without reference measurements. Samples are placed on a rotary table inside the enclosure and measured. Several key metrology features provide long-term hardware stability and enable the MCT225 to achieve MPE(SD) of 9+L/50µm.

## FEATURES

- Temperature-controlled enclosure
- Liquid-cooled X-ray source
- Finite element Analysis (FeA) optimized manipulator
- High-precision linear guideways
- High-resolution optical encoders
- High-resolution 4-megapixel detector

## ALL ANALYSIS IN ONE GO



# Intelligent software

Intuitive and user-friendly software is essential to simplify the process of CT scanning complex samples for accurate inspection. Developed in-house, Inspect-X is designed to streamline the process of acquiring and reconstructing CT data, for both advanced and beginner users. The focus of Inspect-X is on intelligence, offering users only the information they need at any moment, therefore simplifying the task at hand.

## FLEXIBLE SOLUTIONS

Inspect-X has multiple scanning techniques to meet the most demanding of applications from conventional circular CT scanning to X.Tend, which extends the vertical scan height of the X-ray system and Limited Angle, a method for improving the resolution of smaller regions of interest on a sample.

## FULLY PROGRAMMABLE SOFTWARE

Inspect-X is unique in the X-ray CT market, offering unparalleled control through the use of its programmable interface. The possibilities are infinite, allowing custom experimentation, for example time-lapse CT or complete integration of the system within your production line.

## CT WIZARD

Intuitive guide through the steps to acquiring CT data.

## FAST RECONSTRUCTION

Industry leading reconstruction, developed and controlled in-house.

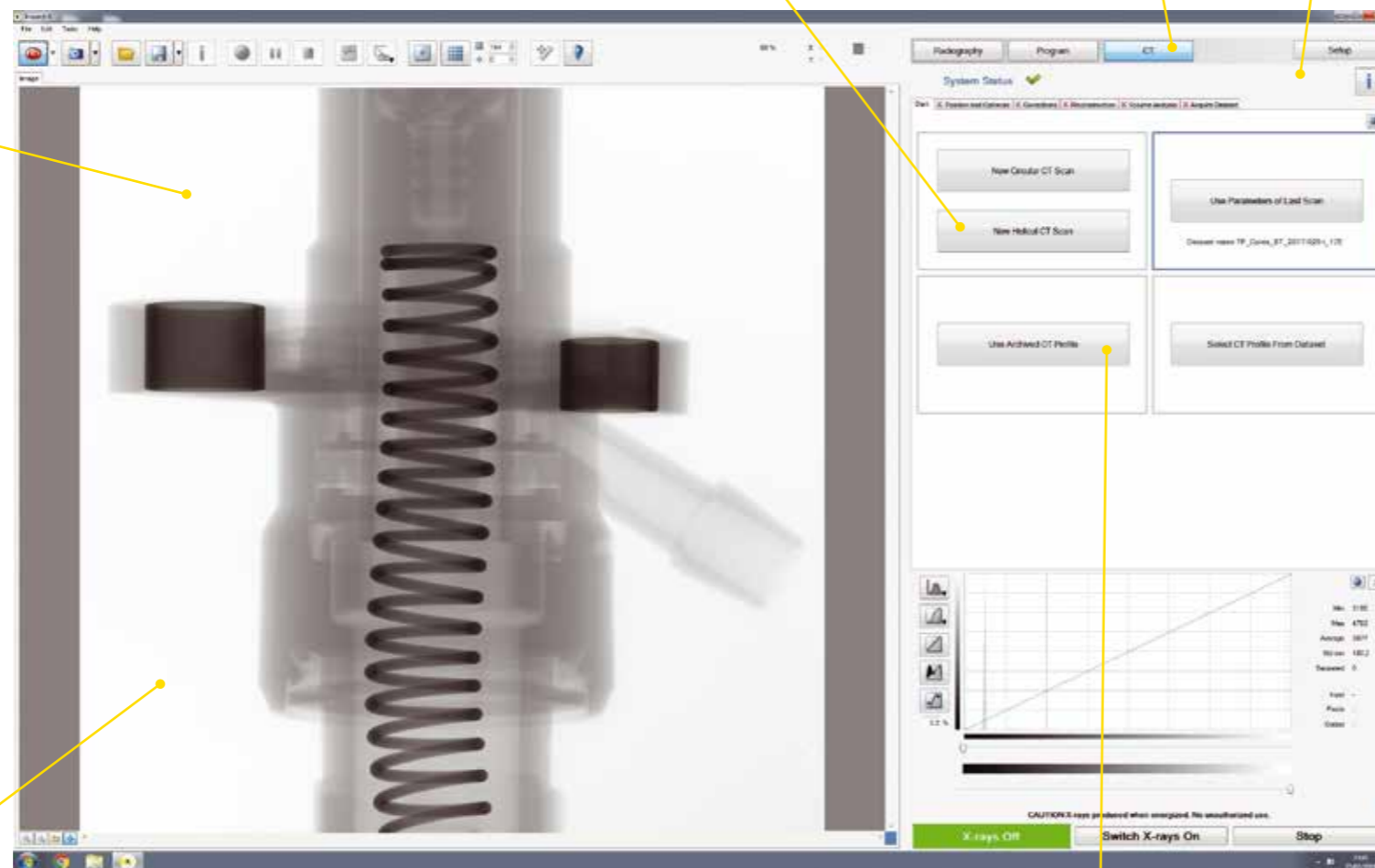

## SIMPLE INTERFACE

With a large radiograph image and clear icons, the simple user interface reduces the operators learning curve.

## ONE TOUCH

After selecting the part type from the scan library, only one button has to be pressed to start the scan, reconstruct the data, perform the analysis and output a results file.

## Nikon CT Automation A major step closer to zero-defect production

### BATCH INSPECTION IS STANDARD WITH INSPECT-X SOFTWARE

Batch inspection allows automation of multiple scans with manual part handling.



### SERIES INSPECTION WITH AUTOLOADER

Semi-automated inspection allows automation of all tasks with multiple part loading.



### FULL AUTOMATION WITH NIKON AUTOMATION OPC UA INTERFACE

In-line automation allows full integration to your production line.



# Advanced scanning technologies improve resolution, scan volume, and speed

# Enabling automated inspection, calibration, and evaluation



## X.Tend Helical CT

Tall objects can be scanned in a single acquisition process, eliminating artefacts introduced by the cone beam and multi-scan stitching. This also provides the benefit of scanning objects at higher magnification, resulting in significantly higher resolution.

► 400 mm tall Rocket Firework [scanned with X.Tend Helical CT]

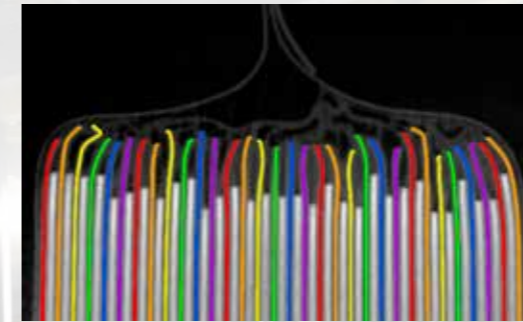

## LiB.Overhang Analysis

Automatic high-speed analysis of anode overhang in Lithium-ion batteries. Cutting-edge Deep Learning AI precisely and reliably analyses the fastest CT scans, exporting repeatable results in a machine-readable format. LiB.Overhang Analysis enables closed-loop process control resulting in improved product quality and significantly reduced scrap.

## Offset.CT

Objects wider than the detector itself can be captured in a single scan. This also allows smaller wide objects to be scanned at considerably higher magnification, providing enhanced detail.

► Heated Car Steering Wheel [scanned with Offset.CT]

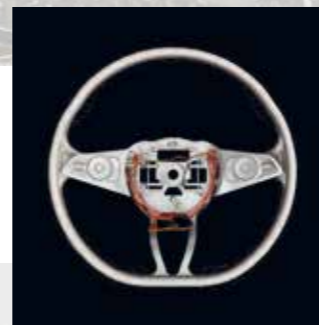

## Dual.Material CT

An innovative reconstruction technique for high throughput production environments that reduces streak and beam hardening artefacts caused by metal and other dense parts in dual-material samples. Discrimination between materials is greatly improved, resulting in clearer visualisation and facilitating automatic inspection. Dual. Material CT eliminates the need for long scan times and manual postprocessing routines.



Traditional reconstruction

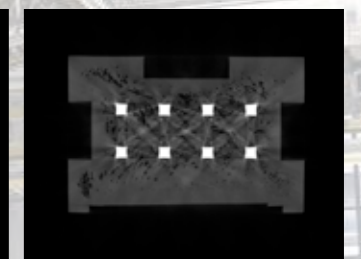

With Dual.Material CT



## Half.Turn CT

This is designed for high throughput environments where fast cycle times are most important. This productivity gain is achieved by acquiring and reconstructing approximately half the data of conventional circular CT without loss of resolution or image quality.

► Lithium-Ion Battery Pouch Cell [scanned with Half.Turn CT]



## ASTM E2737 Detector Evaluation Kit

The condition of flat panel detectors has a considerable influence on the efficiency and accuracy with which features are detected and measured, so evaluating and tracking their performance over time is crucial. Nikon's unique hardware and software evaluation kit enables detailed trend analysis and performance tracking in accordance with ASTM E2737 and produces clear graphical visualisation of results, all within a fully automated process.

## Tilted CT

Maximizes the geometric magnification and, therefore, the resolution of planar or high aspect ratio objects with a small region of interest. This is made possible by tilting the component's axis of rotation, which also yields superior image quality in areas previously masked by more dense material.

► Cylindrical Aluminium Extrusion [scanned with Tilted CT]

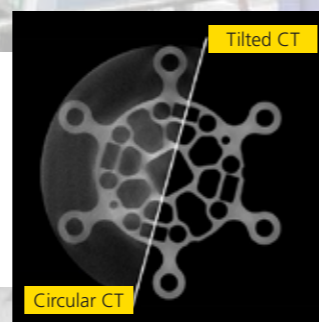

## Local.Calibration

Allows fast, automated calibration of voxel size at any CT scan position, rather than the user having to perform the function manually. This leads to a radical improvement in measurement accuracy for metrology applications. As the CT scan position is calibrated with reference to a known artefact, measurements can be made with high confidence.



# Specifications

Sources					
Nikon Microfocus X-ray Sources	Max. kV	Max. power	Focal spot size range		System
180 kV Transmission Target	180 kV	20 W	1 µm up to 3 W	20 µm at 20 W	XT H 225 and XT H 225 ST 2x
225 kV Reflection Target	225 kV	225 W	3 µm up to 7 W	225 µm at 225 W	XT H 225, MCT225 and XT H 225 ST 2x
225 kV Multi-Metal Target	225 kV	225 W	3 µm up to 7 W	225 µm at 225 W	XT H 225 and XT H 225 ST 2x
225 kV Rotating Target 2.0	225 kV	450 W	10 µm up to 30 W	160 µm at 450 W	XT H 225 ST 2x

Detectors					
16-bit Detectors	Field of View	Pixel Size	Max. frame rate		System
			at 1x1 binning	at 2x2 binning	
Varex 2520 Dx	250 × 200 mm	127 µm	12.5 fps	30 fps	XT H 225
Varex XRD 1620	400 × 400 mm	200 µm	3.75 fps	7.5 fps	MCT225 and XT H 225 ST 2x
Varex XRD 1621 EHS	400 × 400 mm	200 µm	15 fps	30 fps	XT H 225 ST 2x
Varex XRD 4343CT	430 × 430 mm	150 µm	15 fps	30 fps	XT H 225 and XT H 225 ST 2x

	XT H 225	MCT225	XT H 225 ST 2x
<b>Manipulator</b>			
# Axes	5	4	5
Max. Circular CT Diameter	280 mm (Ø)	250 mm (Ø)	265 mm (Ø)
Max. FID (nominal)	970 mm	1,175 mm	1,110 mm
FID Type	Manual	Fixed	Motorised
Max. Sample Mass	15 kg	50 kg 5 kg (metrology)	50 kg

	XT H 225	MCT225	XT H 225 ST 2x
<b>Cabinet</b>			
Length	1,830 mm	2,414 mm	2,414 mm
Width	875 mm	1,275 mm	1,275 mm
Height	1,987 mm	2,202 mm	2,202 mm
Max. Mass	2,250 kg	4,200 kg	4,200 kg

Note: All figures are intended for summary purposes and may vary based on exact system configuration. Contact your Nikon representative for detailed specifications of each configuration.



**NIKON CORPORATION**  
1-5-20, Nishioji, Shinagawa-ku, Tokyo 140-8601, Japan  
<https://industry.nikon.com>

ISO 14001 Certified  
for NIKON CORPORATION

ISO 9001 Certified  
for NIKON CORPORATION  
Industrial Metrology Business Unit

**NIKON METROLOGY EUROPE NV**  
Interleuvenlaan 86  
B-3001 Leuven, Belgium  
Tel: +32 16 74 01 00  
Sales.Europe.NM@nikon.com

**NIKON METROLOGY, INC.**  
12701 Grand River Road, Brighton,  
MI 48116 U.S.A.  
Tel: +1 810 220 4360  
Sales.NM-US@nikon.com

**NIKON INSTRUMENTS KOREA CO. LTD.**  
KOREA Tel: +82 2 6288 1900  
**NIKON SINGAPORE PTE. LTD.**  
SINGAPORE Tel: +65 6559 3651  
NSG.Industrial-sales@nikon.com

**NIKON METROLOGY SARL**  
UNITED KINGDOM Tel: +44 1332 811 349  
Sales.UK.NM@nikon.com

**NIKON METROLOGY - MÉXICO**  
Sales.NM-MX@nikon.com

**PT. NIKON INDONESIA**  
INDONESIA Tel: +62 267 864 3949  
PTN.Instruments@nikon.com

**NIKON METROLOGY SARL**  
FRANCE Tel: +33 1 60 86 09 76  
Sales.France.NM@nikon.com

**NIKON PRECISION (SHANGHAI) CO., LTD.**  
CHINA Tel: +86 21 6841 2050 (Shanghai branch)  
CHINA Tel: +86 10 5831 2028 (Beijing branch)  
CHINA Tel: +86 20 3882 0551 (Guangzhou branch)  
Web.Nis@nikon.com

**NIKON SALES (THAILAND) CO., LTD.**  
THAILAND Tel: +66 2633 5100

**NIKON METROLOGY GMBH**  
GERMANY Tel: +49 211 45 44 69 51  
Sales.Germany.NM@nikon.com

More offices and resellers at <https://industry.nikon.com>