



ECLIPSE LV100N POL LED Ci-POL

Polarizing Microscopes



The highest level of optical quality, operability and stability for polarizing microscopy

- LV100N POL LED is equipped with a bright and long-life LED light source with reduced heat-induced focus drift.
- Centerable nosepiece with high precision.
- The LV100N POL LED's stage provides smooth, accurate movement.
- 30mm long focus stroke accepts tall samples.

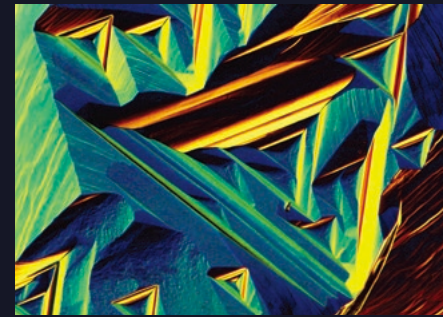

1

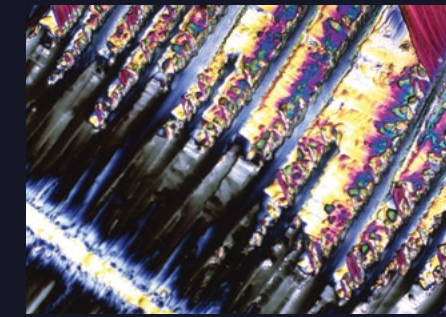

2

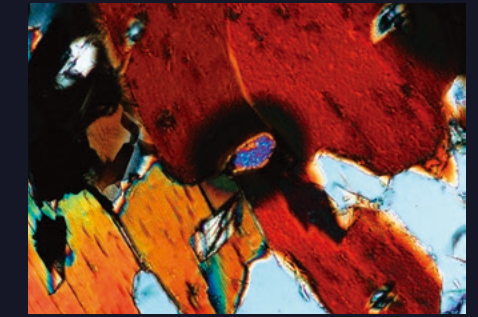

3



Reversed centering quintuple nosepiece

Up to five objectives can be mounted and all objective positions are centerable. The DIN-compliant compensator slot accepts various compensators for qualitative or quantitative measurements.



High-precision rotating stage

The LV100N POL LED stage is large, pre-adjusted, and click-stops in 45° increments. The smooth stage movement allows stable and easy rotation, providing high operability and high-quality polarized images. The underneath support for the stage table is close to the optical axis. Together with the steel cross roller guides, this provides outstanding stability and durability during regular use.

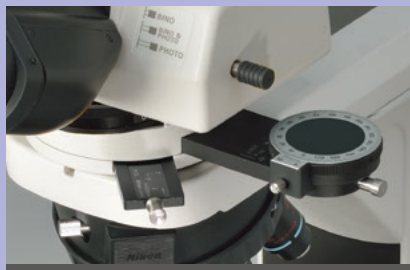

Intermediate tube

The intermediate tube incorporates a Bertrand lens as standard, enabling both the observation and capture of conoscopic and orthoscopic images. The Bertrand lens is focusable and centerable. The high precision slider-type analyzer can be rotated a full 360° with a precision vernier scale. A P-CL tint plate slider with full and quarter wave plates and an empty space is available.

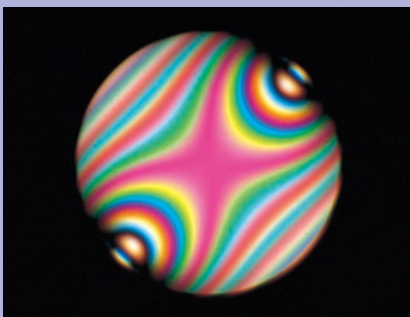

Conoscopic image of mica / CFI Achromat P 40X



ECLIPSE Ci-POL
(Diascopic illumination)

ECLIPSE Ci-POL
(Diascopic/Episcopic illumination)

ECLIPSE LV100N POL LED
(Diascopic illumination)

ECLIPSE LV100N POL LED
(Diascopic/Episcopic illumination)

Objectives for polarizing observation

CFI Achromat P objective series (for diascopic illumination)

The unique Nikon CFI60 objectives successfully deliver longer standard working distances and high numerical apertures, offering superb image flatness, contrast and cost performance.



CFI TU Plan Fluor EPI P objective series (for diascopic/episcopic illumination)

The CFI TU Plan Fluor EPI P series of CFI60-2 objectives produce pin-sharp aberration-free images regardless of magnification.



Nikon CFI optics employ an eco-glass that is manufactured with no harmful substances such as lead and arsenic.

ECLIPSE LV100N POL LED Diascopic illumination type

Outstanding optical performance, perfect for a wide variety of imaging applications and polarizing techniques

LV100N POL LED is equipped with a bright and long-life LED light source. LEDs generate very little heat, greatly reducing focus drift resulting from light source heat.

- Microscope body is designed to realize high robustness.
- Unique stage mount design ensures exceptional stability.
- Nosepiece comes with a DIN standard compensator slot.
- All five objective positions on the nosepiece are centerable.
- Uses CFI60 optics, realizing both high NA and longer standard working distances.
- A clamp-type upper limit focusing mechanism makes for easy, safe sample exchange, protecting both sample and optics from collision damage.

Uniform brightness with diascopic illumination

Nikon's unique fly-eye lens has been employed in diascopic illumination optics. This enables high quality imaging with no variations in luminescence throughout the view field.

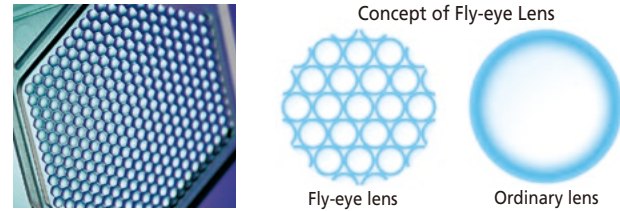

ECLIPSE LV100N POL LED Diascopic/Episcopic illumination type ECLIPSE Ci-POL Diascopic/Episcopic illumination type

Accomplishes advanced polarizing microscopy under both diascopic and episcopic illumination

Both diascopic and episcopic polarizing observations are possible by mounting the LV-UEPI-N Universal Epi-illuminator. It is possible to switch between the illumination techniques of the LV100N POL LED with a simple operation. The epi-illuminator uses a bright, long-life LED light source. The noise-terminator mechanism provides sharp images with high S/N ratios by eliminating stray light. With the optional universal-type nosepiece and DIC accessories including objectives, episcopic differential interference contrast (DIC) microscopy is also possible.



ECLIPSE Ci-POL

(Diascopic/Episcopic illumination type)

* When used with the Ci-POL, LV-UEPI-N requires an external power supply.



ECLIPSE LV100N POL LED
(Diascopic/Episcopic illumination type)

ECLIPSE Ci-POL Diascopic illumination type

A compact polarizing microscope that balances basic performance and ease of use

- Slim and compact, an excessively large working area is not necessary.
- Nosepiece uses the same DIN standard compensator slot design as LV100N POL LED.
- All five objective positions on the nosepiece are centerable.
- Uses CFI60 optics, realizing both high NA and long standard working distances.
- A clamp-type upper limit focusing mechanism makes for easy, safe sample exchange, protecting both sample and optics from collision damage.
- Excellent cost effective and precision manufacturing is balanced with superb basic performance for a polarizing microscope.
- Built-in capture button allows easy imaging with the DS-Fi3 and Digital Sight 10 cameras (Please see page 6).
- Built-in 6V 30W halogen light source.

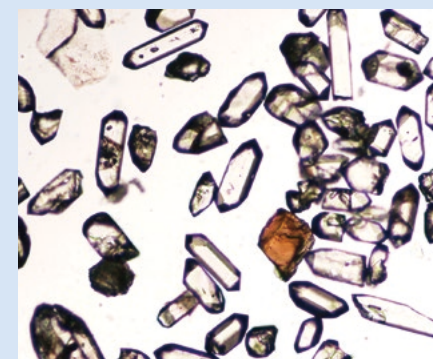
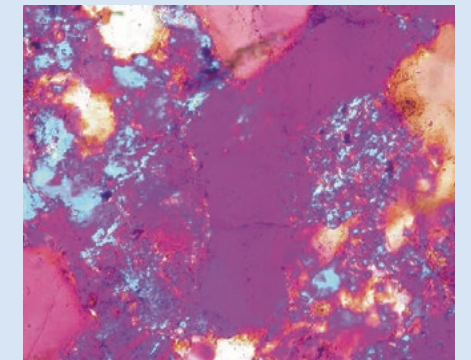
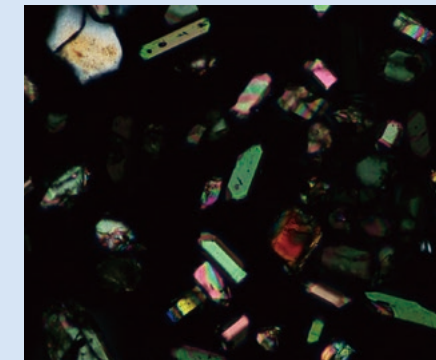
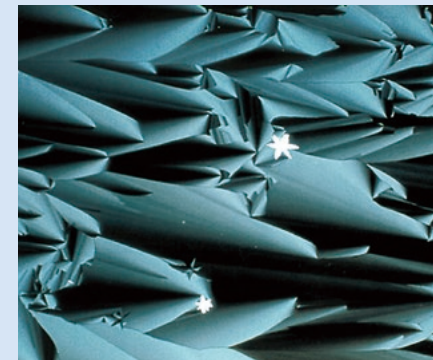

Optional Accessories for Polarizing Observations

Attachable mechanical stage

To improve microscopy efficiency, an attachable mechanical stage can be mounted on the rotating stage to rigidly hold and move the sample.

Cross travel: 35 x 25 mm
Minimum increment: 0.1mm on the vernier

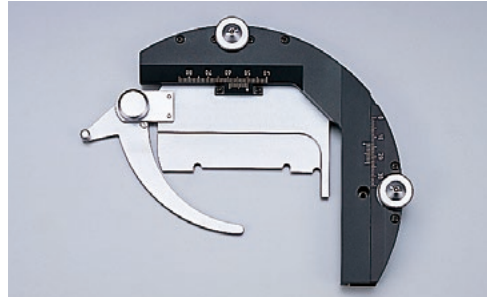

Senarmont compensator

Inserted into the intermediate tube. In addition to the standard use $1/4 \lambda$ plate and a 546 nm (1λ) tint plate (1st order red plate), a Senarmont compensator is also available as an option, for retardation measurements from 0 to 1λ .



Quartz wedge compensator

Inserted into the intermediate tube, this compensator permits retardation measurements from 1 to 6λ orders.



Berek compensator

Inserted into the nosepiece slot, this compensator permits retardation measurements from 0 to 1800 nm.

Manufactured by Nichika Corporation.

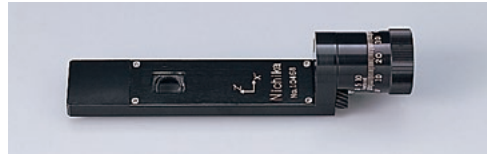

IF 546/12 retardation filter

High-precision interference filter with a 546 nm central wavelength and 12 nm FWHM (full-width at half maximum). Used to increase the precision of retardation measurements.

Digital Camera for Microscopes

When the DS-Fi3 and Digital Sight 10 cameras are connected directly to a PC, the NIS-Elements software allows the acquisition, processing, measurement and analysis of images, as well as data management and report creation.

C-mount camera

DS-Fi3 Microscope Camera

Equipped with a 5.9-megapixel CMOS sensor, the DS-Fi3 enables fast 15 fps acquisition of high definition images of up to 2880 x 2048 pixels with superior color reproduction for vivid polarized images. It also provides smooth live image movement and high sensitivity imaging of weak-light polarization samples.



F-mount camera

Digital Sight 10 Microscope Camera

This high-resolution camera captures both color and monochromatic images at up to 6,000 x 3,984 pixels. This enables the wide range of images to be captured and then many of them to be stitched together making a single and large combined image.



System Diagram

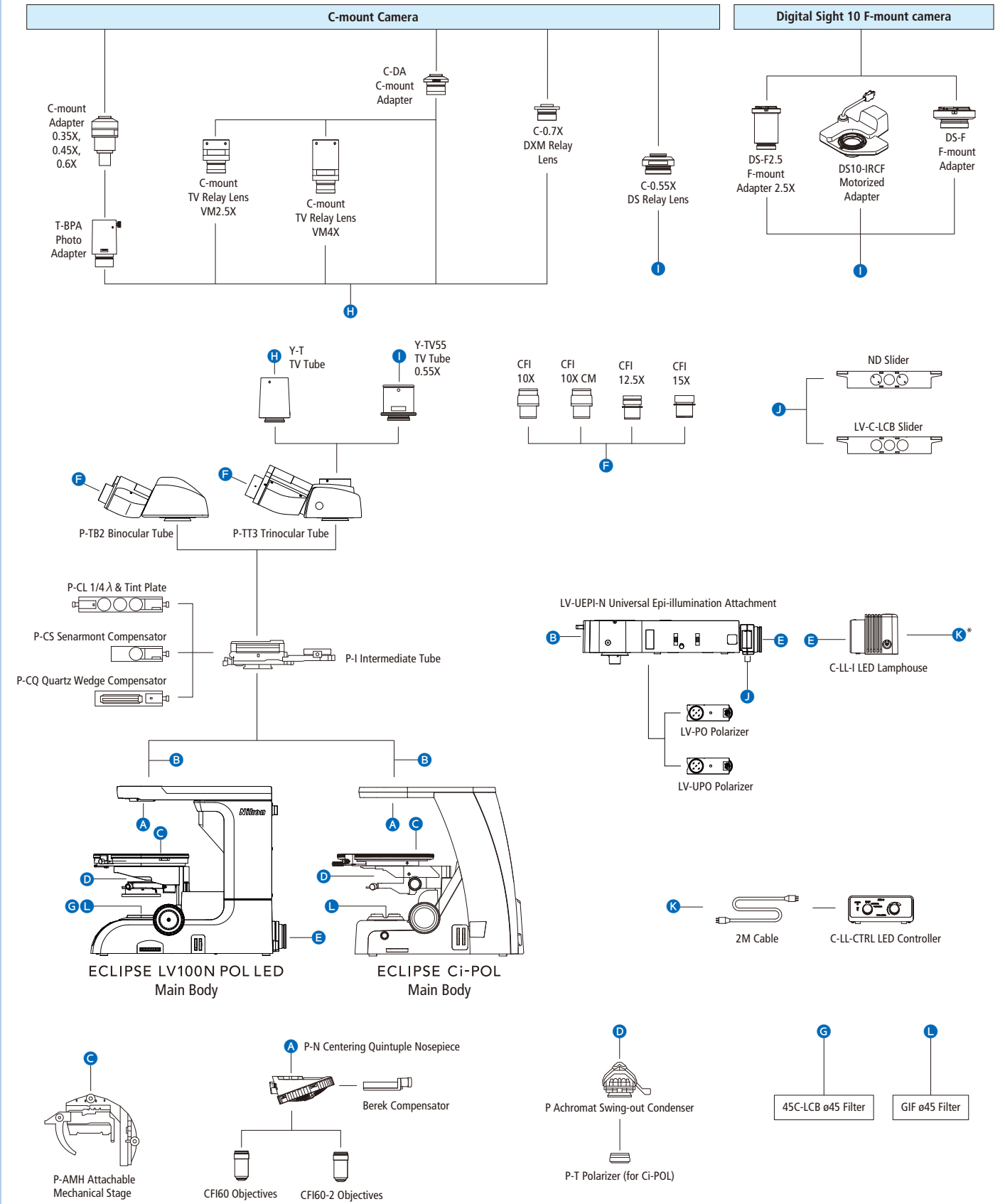

* Ci-POL requires the C-LL-CTRL. LV100N POL LED requires the C-LL-CTRL only when simultaneously using episcopic and diascopic illumination.

Specifications

		ECLIPSE LV100N POL LED	ECLIPSE Ci-POL
Main body	Optical system	CFI60 infinity	
	Illumination	High color rendering LED; 12V-24W power supply built-in; Diascopic/episcopic illumination changeover switch; Fly-eye lens; NCB11, ND8 filters built-in	6V-30W halogen lamp; 6V-30W power supply built-in; ND8, ND4 filters built-in
	Focusing	Coaxial coarse/fine focus knob; Focus stroke: 30mm; Coarse: 14mm per rotation; Fine: 0.1mm; Minimum reading: in 1µm increments	Coaxial coarse/fine focus knob; Focus stroke: 30mm; Coarse: 9.33mm per rotation; Fine: 0.1mm; Minimum reading: in 1µm increments
Eyepieces (F.O.V., mm)		CFI 10X (22), CFI 10X CM (22), CFI 12.5X (16), CFI 15X (14.5)	
Tubes		P-TT3 Trinocular Tube for polarizing microscopy; P-TB2 Binocular Tube for polarizing microscopy	
Intermediate tube		Built-in focusable Bertrand lens removable from optical path; Conoscopic/Orthoscopic observations switchable; Analyzer built-in; Accessory plate/compensator slot	
Analyzer		360° rotary dial; Minimum reading angle 0.1°	
Nosepiece		Centering quintuple nosepiece (detachable); DIN slot	
Stages		Top-grade dedicated circular graduated stage Rotatable 360° horizontally; can be fixed at a specific position; Graduated 360° (in 1° increments); Click stops each 45°; Attachable mechanical stage: 35 x 25 mm travel; vernier 0.1mm	Ball bearing rotary stage; Rotatable 360° horizontally; can be fixed at a specific position; Graduated 360° (in 1° increments); Rotation clamp equipped; Attachable mechanical stage: 35 x 25 mm travel; vernier 0.1mm
Condenser		Dedicated strain-free swing-out type; P Achromat NA 0.9	
Polarizers		Fixed to the bottom of the condenser holder; with scale markings	No scale markings
Objectives (Polarizing sets)		CFI Achromat P 4X, P 10X, LWD P 20X, P 40X, P 100X Oil CFI TU Plan Fluor EPI P 5X, P 10X, P 20X, P 50X, P 100X	
Episcopic illuminator		LV-UEPI-N Universal Epi-illuminator (The LV100N POL LED has a built-in 12V-24W power supply)	LV-UEPI-N Universal Epi-illuminator (The Ci-POL requires an external power supply C-LL-CTRL)
Compensators		P-CL Standard 1/4 λ & tint plate, quartz wedge or Senarmont compensator can be inserted into intermediate tube slot	
Power consumption		0.7A/58W	0.8A/38W
Weight		Approx. 17kg (standard trinocular set)	Approx. 14kg (standard binocular set)

Dimensional Diagram

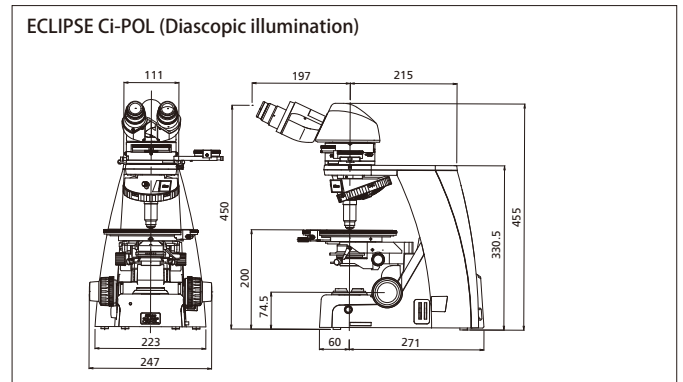
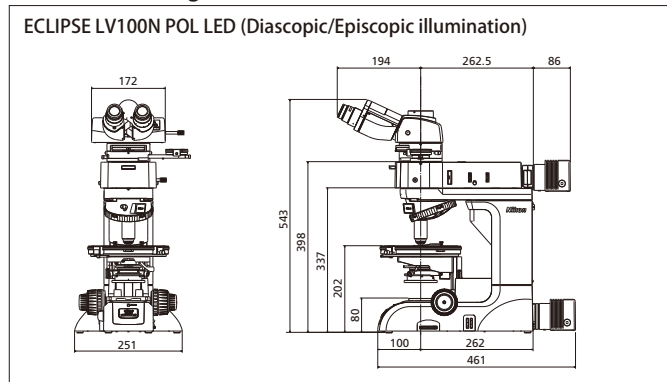

Unit: mm

Images courtesy of:
Dr. Kazuhiro Suzuki and Dr. Takenori Kato, Center for Chronological Research, Nagoya University (● on page 3, ● on page 5)
Ron Sturm, Construction Technology Laboratories, Inc., U.S.A. (● on page 5)
Mike Davidson, Florida State University, U.S.A. (● on page 3, ● on page 5)

Company names and product names appearing in this brochure are their registered trademarks or trademarks.
N.B. Export of the products* in this brochure is controlled under the Japanese Foreign Exchange and Foreign Trade Law.
Appropriate export procedure shall be required in case of export from Japan.
*Products: Hardware and its technical information (including software)

 WARNING	TO ENSURE CORRECT USAGE, READ THE CORRESPONDING MANUALS CAREFULLY BEFORE USING YOUR EQUIPMENT.
--	--

Specifications and equipment are subject to change without any notice or obligation on the part of the manufacturer. March 2025 ©2025 NIKON CORPORATION



NIKON CORPORATION

Head office
1-5-20, Nishioi, Shinagawa-ku, Tokyo 140-8601, Japan
<https://www.healthcare.nikon.com/>
<https://industry.nikon.com/>

Manufacturer
471, Nagaodai-cho, Sakae-ku, Yokohama, Kanagawa 244-8533, Japan

ISO 14001 Certified
for NIKON CORPORATION

ISO 9001 Certified
for NIKON CORPORATION
Industrial Solutions Business Unit

NIKON INSTRUMENTS INC.
1300 Walt Whitman Road, Melville, N.Y. 11747-3064, U.S.A.
phone: +1-631-547-8500; +1-800-52-NIKON (within the U.S.A. only)
fax: +1-631-547-0306
<https://www.microscope.healthcare.nikon.com/>

NIKON METROLOGY, INC.
12701 Grand River Road, Brighton, MI 48116 U.S.A.
phone: +1-810-220-4360
E-mail: Sales.NM-US@nikon.com

NIKON EUROPE B.V.
Stroombaan 14, 1181 VX Amstelveen, The Netherlands
phone: +31-20-7099-000
https://www.microscope.healthcare.nikon.com/en_EU/

NIKON METROLOGY EUROPE NV
Interleuvenlaan 86, 3001 Leuven, Belgium
phone: +32-16-74-01-01
E-mail: Sales.NM@nikon.com

NIKON PRECISION (SHANGHAI) CO., LTD.
CHINA phone: +86-21-6841-2050 fax: +86-21-6841-2060
(Beijing branch) phone: +86-10-5831-2028 fax: +86-10-5831-2026
(Guangzhou branch) phone: +86-20-3882-0550 fax: +86-20-3882-0580
<https://www.nikon-precision.com.cn/>

NIKON INSTRUMENTS KOREA CO., LTD.
KOREA phone: +82-2-6288-1900 fax: +82-2-555-4415
https://www.microscope.healthcare.nikon.com/ko_KR/

NIKON SINGAPORE PTE. LTD.
SINGAPORE phone: +65-6559-3651 fax: +65-6559-3668

PT. NIKON INDONESIA
INDONESIA phone: +62-213-873-5005

NIKON SALES (THAILAND) CO., LTD.
THAILAND phone: +66-2633-5100

NIKON AUSTRALIA PTY LTD
AUSTRALIA phone: +61-2-8767-6900

NIKON INDIA PVT. LTD.
INDIA phone: +91-124-4688-500

NIKON METROLOGY - MÉXICO
E-mail: Sales.NM-US@nikon.com

NIKON CANADA INC.
CANADA phone: +1-905-625-9910 fax: +1-905-602-9953

NIKON ITALY, BRANCH OF NIKON EUROPE B.V.
ITALY phone: +39-55-300-96-01

NIKON EUROPE B.V., AMSTELVEEN, ZWEIGNIEDERLASSUNG SCHWEIZ (EGG/ZH)
SWITZERLAND phone: +41-43-277-2867

NIKON ÖSTERREICH, ZWEIGNIEDERLASSUNG DER NIKON EUROPE B.V.
AUSTRIA phone: +43-1-972-6111

NIKON UK, BRANCH OF NIKON EUROPE B.V.
UNITED KINGDOM: phone: +44-208-247-1717

NIKON METROLOGY UK LTD.
UNITED KINGDOM: phone: +44-1332-811-349
E-mail: Sales.UK.NM@nikon.com

NIKON FRANCE, SUCCURSALE DE NIKON EUROPE B.V.
FRANCE phone: +33-1-4516-4516

NIKON METROLOGY SARL
FRANCE phone: +33-1-60-86-09-76
E-mail: Sales.France.NM@nikon.com

NIKON DEUTSCHLAND, ZWEIGNIEDERLASSUNG DER NIKON EUROPE B.V.
GERMANY phone: +49-211-9414-888

NIKON METROLOGY GMBH
GERMANY phone: +49-211-45-44-69-51
E-mail: Sales.Germany.NM@nikon.com