



# ECLIPSE MA200 MA100N

Inverted Metallurgical Microscopes



# MA200 / MA100N

## Features



### MA200

Offers high stability, durability, and a smaller footprint than conventional models, as well as easy access to the stage handle, the nosepiece, the BF/DF change lever, and diaphragms, all located on the front side.



### MA100N

Designated for brightfield and simple polarizing observation, the MA100 is a cost-effective solution to manufacturing and QA/QC situations in industries such as automotive/electronic parts and industrial machinery/tools.

	Brightfield	Darkfield	Simple polarizing	DIC	Fluorescence
<b>Compatible observation methods</b>	○	○	○	○	△
<b>Compatible illuminators</b>	*DIA illuminator is available for transmitted light observation. △ : only available with Halogen Lamp and Fiber Illumination				
<b>Magnification module</b>	<ul style="list-style-type: none"> <li>• LV-LH50PC 12V50W Halogen Lamp Illuminator</li> <li>• C-HGFI HG Precentered Fiber Illuminator (option)</li> <li>• LV-LL LED Lamphouse</li> </ul>				
<b>Compatible stages</b>	<ul style="list-style-type: none"> <li>• 1x/1.5x/2x</li> </ul>				
	Brightfield	Darkfield	Simple polarizing	DIC	Fluorescence
	○	—	○	—	—
	*Dedicated reflected illumination models.				
	<ul style="list-style-type: none"> <li>• High-intensity white LED Illuminator (internal power supply)</li> </ul>				
	<ul style="list-style-type: none"> <li>• MA-SR-N Rectangular 3-plate Stage N (stroke: 50 x 50 mm)</li> <li>• MA-SP-N Plain Stage N</li> <li>• TS2-S- SM Mechanical Stage (stroke: 126 x 78 mm)</li> </ul> *Please use in combination with MA-SP-N Plain stage N.				

# ECLIPSE MA200

An ideal inverted microscope offered only by Nikon



## Front Operation

Delivers ease-of-use by placing all important controls at the front of MA200N.

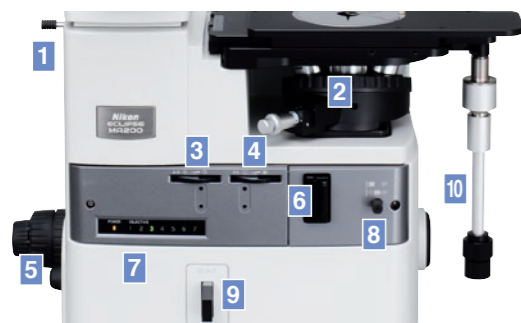

- |  |   |
|--|---|
| 1 Optical path changeover lever (vertical tube/binocular tube) | 6 Operation port for the polarizer/analyzer unit and the fluorescent unit |
| 2 Nosepiece  | 7 Display   |
| 3 Aperture diaphragm dial                                      | 8 BD field changeover lever   |
| 4 Field diaphragm dial   | 9 Scale slider slot   |
| 5 Brightness control dial                                      | 10 Flexible handle stage  |

### Quick Status Check



Automatically detects the address of the objective lens currently in use and displays it on the main unit front panel.

The observation position of the objective lens and sample can be checked easily from the microscope's front panel.

## Box Structure

The unique box structure is 1/3 smaller than conventional models and offers improved durability.

### Compact structure with a depth of 315 mm

A box shaped microscope, not only the width but also the depth is reduced dramatically: The foot print is only one-third of the conventional model!

### High stability and durability

Reduced vibration during high-power observation, offering a highly rigid microscope.

## Evolved Optical Performance

Provides a more ergonomic observation with clearer images.

### Super-wide field of view

A sample with a diameter of just 25 mm can be observed in an one field of view by combining the ultra wide field of view eyepiece and 1x objective lens.

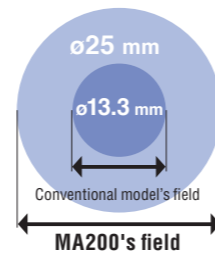

• T Plan EPI 1x  
Wide field of view

### Even Illumination

Improved uniformity of illumination delivers clear images, especially for digital imaging.

### Combine images with the stitching feature

Can combine up to eight images with uniform lighting and no seams.

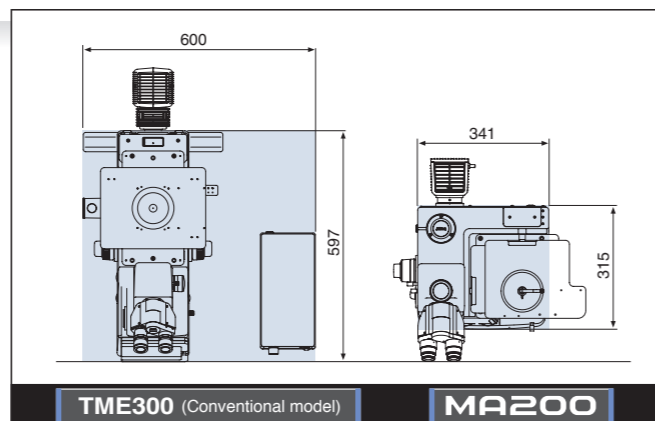
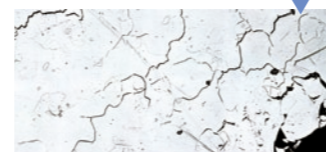

## Combination with Digital Camera

The MA200 allows detection of information and control of objective lenses, enabling optimization of the conditions vital for image acquisition.

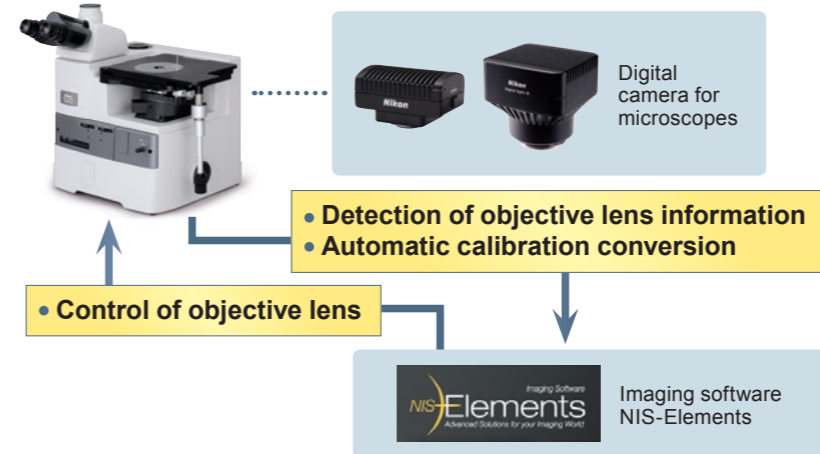

Note: With NIS-Elements L and F, functions above are not available. Use NIS-Elements D/Br/Ar.

## Illumination

### Expanded lineup

Added a compact LED illuminator to the existing lineup. With the use of LED, Nikon illuminators are power saving and achieve long life.



LV-LL LED Lamphouse

## Accessories

### Stage

Samples can be rotated by the stage clip. The stage delivers high durability needed to support heavy samples.

1 MA-2 SR Stage



### Holders

A full lineup is available that correspond to a variety of sample shapes.

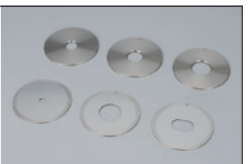

### Polarizing Units

Polarizing observation is effective for birefringence samples. MA2-PA unit is suitable for observation of aluminium.



• Single-action operation • Aluminium sample

Links the attachment/release of the analyzer/polarizer.

- 1 MA2-PA Unit
- 2 MA2-UPA Unit\*
- 3 MA2-λP λ Plate

\*It is suitable for inspecting aluminium sample.

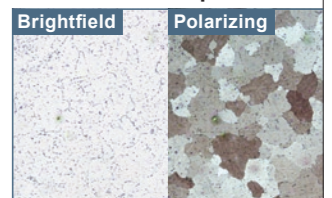

### DIC Units

Standard and high contrast type DIC prism are available to match needs of the sample. These prisms are effective for observation of minute step heights.

- 1 MA2-PA Unit
- 2 L-DIHC DIC Prism (High Contrast)
- 3 L-DIC DIC Prism



### Nosepiece & Magnification Module

Enables communication of objective lens position, magnification and intermediate magnification module information with the NIS-Elements image software.

- 1 MA2-MC Magnification Module
- 2 LV-NU51 Intelligent Universal Quintuple Nosepiece



### Grain Size Reticle & Scale

Overlays a pattern onto the observed image. The Grain Size Reticle is used for grain size analysis and complies with the JIS G0551 and ASTM E112 standards. The Scale displays a scale for each objective lens magnification.

- 1 MA2-GR Grain Size Reticle JIS G0551/objective lens 10x (100x magnification) ASTM E112/objective lens 10x (100x magnification)
- 2 MA2-MR Scale



# ECLIPSE MA100N

A durable, user-friendly Inverted Microscope with superior image quality, a small footprint and great cost performance.



## Illumination

### Employment of high-intensity LED illumination (Eco-illumination)

Compared to conventional halogen illumination, these high intensity LED sources need only about one third of consuming electricity and last approximately 30 times longer. The MA100N ensures stable sample observation with uniform color temperature even in different light intensity.



## Stage

### Controlled stability even with heavy samples/ Boasts superior durability

The MA-SR-N Rectangular Stage was developed especially for the MA100N. The three-plate structure allows for observation of heavy samples, such as a grinder resin mounted samples.



## Compact Body

### Redesigned to be smaller

Designed for LED illumination, the footprint is 11% smaller than conventional models, allowing users to have more installation choices.

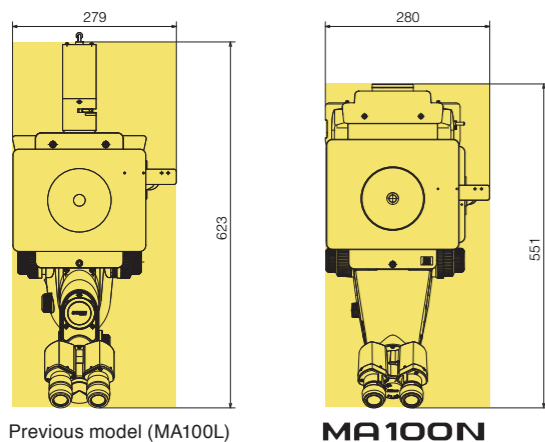

## Aperture Diaphragm

### Standard with MA100N

The epi illuminator comes standard with a variable aperture diaphragm to control image contrast and depth of field.



## Accessories



### Basic stage set

A triple-platform stage structure lets you use heavy samples.

- 1 MA-SR-N Rectangular Stage N
- 2 Specimen Holder (ø20/30/40 mm aperture)
- 3 MA-SH3 Specimen Holder 3
- 4 MA-SRSH1 Universal Specimen Holder



### Grain size reticle

The class of grain size in a sample can be easily distinguished while observing its image.

- 1 MA100-EPRGS Grain Size Reticle

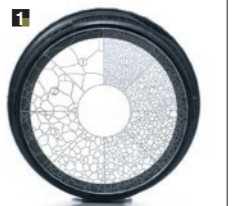

### Digital Camera

Redesigned with optical systems suitable for sample observations. The camera port is located on the side of MA100N to provide improved visibility of the stage.

- 1 Microscope Camera DS-Fi3
- 2 C-0.63x-TS2 C-mount Adapter
- 3 TS2-P-CF Camera port 100



### Other accessories

- 1 TI-SM Mechanical Stage CH
- 2 MA-SP-N Plain Stage N
- 3 MA-SH2-N Specimen Holder 2N
- 4 MA-S-HU Universal Holder
- 5 MA-SH3 Specimen Holder 3
- 6 MA-SRSH 25-40 Holder
- 7 MA-SRSH1 Universal Specimen Holder
- 8 MA-SH1-N Specimen Holder 1N
- 9 MA-P/A Simple Polarizer

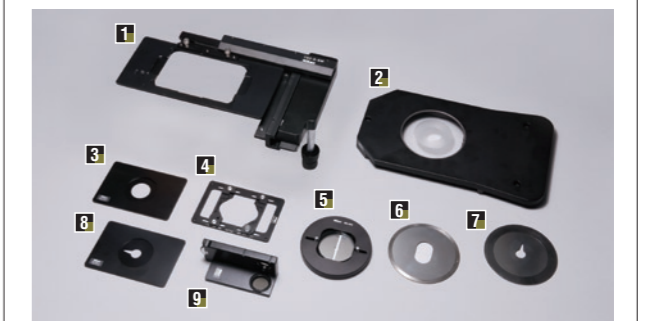

# Accessories

## CFI60-2

Nikon's CFI60 optical systems are highly evaluated for their unique concept of high NA combined with a long working distance. These lenses have been developed further and evolved achieving the apex in long working distance specifications, correct chromatic aberration, and an optimized lens weight.

Standard objective lenses

### TU Plan Fluor Series

EPI/BD 5x/10x/20x/50x/100x

Enable brightfield, darkfield, simple polarizing, sensitive polarizing, differential interference, and epi-fluorescence observations with just one lens. Achieves superior chromatic aberration performance with long working distance for all magnifications to adapt to any application.



\*Brightfield observation (EPI) objective lens

Model	Magnification	NA	Working Distance (mm)
TU Plan Fluor EPI (brightfield type)	5x	0.15	23.5
	10x	0.30	17.5
	20x	0.45	4.5
	50x	0.80	1.0
TU Plan Fluor BD (brightfield/ darkfield type)	5x	0.15	18.0
	10x	0.30	15.0
	20x	0.45	4.5
	50x	0.80	1.0

Long working distance objective lenses

### TU Plan ELWD Series

EPI/BD 20x/50x/100x

With the phase Fresnel lenses, these objective lenses enable long working distances while offering higher level chromatic aberration correction than conventional objective lenses. This improves operability for samples with different heights.



\*Brightfield observation (EPI) objective lens

Model	Magnification	NA	Working Distance (mm)
TU Plan EPI ELWD (brightfield type)	20x	0.4	19.0
	50x	0.6	11.0
	100x	0.8	4.5
TU Plan BD ELWD (brightfield/ darkfield type)	20x	0.4	19.0
	50x	0.6	11.0
	100x	0.8	4.5

Low-magnification objective lenses

### T Plan EPI EPI 1x/2.5x

Both clear observation using a conventional analyzer/polarizer and operability-oriented observation without the need of an analyzer/polarizer are possible.



Model	Magnification	NA	Working Distance (mm)
T Plan EPI (brightfield type)	1x	0.03	3.8
	2.5x	0.075	6.5

Apochromatic objective lenses

### TU Plan Apo Series

EPI/BD 50x/100x/150x

By using phase Fresnel lenses, these objective lenses achieve significantly longer operating distances while maintaining the superior chromatic aberration performance of apochromatic lenses.



\*Brightfield observation (EPI) objective lens

Model	Magnification	NA	Working Distance (mm)
TU Plan Apo EPI (brightfield type)	50x	0.8	2.0
	100x	0.9	2.0
	150x	0.9	1.5
TU Plan Apo BD (brightfield/ darkfield type)	50x	0.8	2.0
	100x	0.9	2.0
	150x	0.9	1.5

## Other Lenses

Brightfield objective lens

### CFI L Plan EPI 40x

A 40x objective lens is best for metal analysis.

NA: 0.65 W.D.: 1.0 mm



## Digital camera system for microscopes DIGITAL SIGHT SERIES

Microscope camera

### Digital Sight 1000

Equipped with a 2 megapixel CMOS image sensor, it can capture full HD microscope images. By connecting a microscope to this camera and HDMI monitor, movies and images can be captured and saved onto a pre-inserted SD card in the camera.

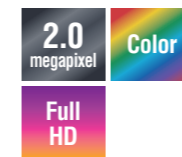

### DS-Fi3

Three main features of the previous models, high-resolution, high sensitivity and low noise, and high-speed live display are offered in 1 camera.

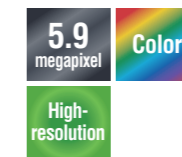

### Digital Sight 10

This high-resolution camera captures both color and monochromatic images at up to 6,000 x 3,984 pixels. This enables the wide range of images to be captured and then many of them to be stitched together making a single and large combined image.

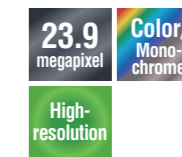

Frame Rate	30 fps (1920x1080)	30 fps (1440x1024)	66 fps (1920x1080)
Max Recordable Pixels	1920x1080	2880x2048	6000x3984

## Imaging software NIS-Elements

Using a tablet PC

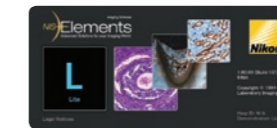

Simply installing NIS-Elements L on a tablet PC enables setting and control of Digital Sight 1000/DS-Fi3/Digital Sight 10 microscope cameras, live image display, and image acquisition.

Using a desktop PC



### A wide variety of tools

NIS-Elements L enables the conducting of simple measurements on images, with input of lines and comments. These can also be written onto and saved with the image, and measurement data can be output.

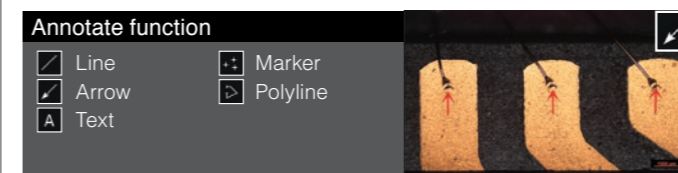
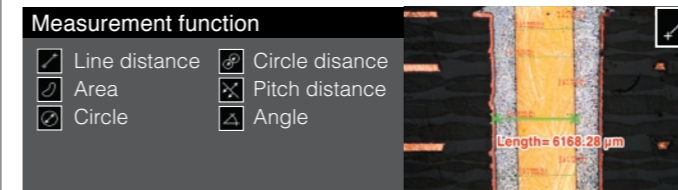

### Image Stitching

Stitches together images acquired from multiple fields of view to create one image.

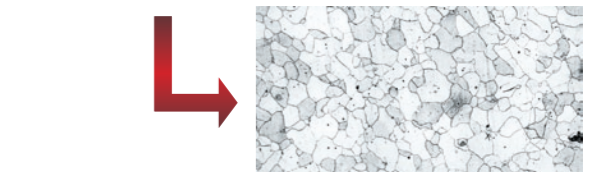
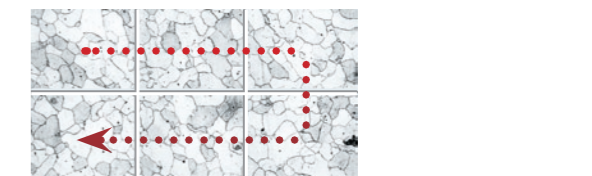

### EDF (Extended Depth of Focus)

Create a single, all-in-focus image from images of differing focus.

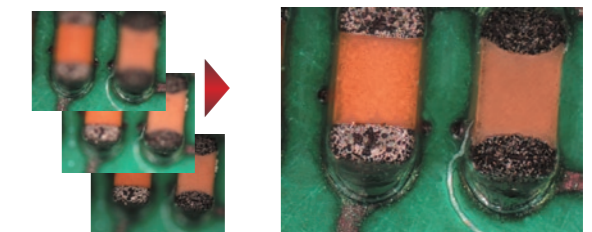

### Scene Mode

Ten camera setting patterns for optimal color reproduction and contrast for each microscope light source, observation method and type of sample, as well as custom settings, can be selected.

- Wafer/IC
- Metal, Ceramic/Plastic
- Circuit board
- Flat Panel Display

\* See the "Digital Camera Digital Sight Series for Microscopes" brochure for details on Digital Sight features.



## Specifications (MA200)

MA200		
<b>Main body</b>	<b>Focusing mechanism</b>	Focusing nosepiece (Fixed stage) Coaxial coarse/fine adjustment knob (torque adjustable) Coarse adjustment of 4.0 mm per rotation, fine adjustment of 0.1 mm per rotation
	<b>Illumination</b>	With flare prevention, Built in UV cut filter
		Field diaphragm: dialing continuous variable (centerable), Aperture diaphragm: dialing continuous variable (centerable)
		Filter: Double turret (ND16, ND4/GIF, NCB, Additional option available), Polarizing block (Selectable with or without 1/4 $\lambda$ Plate) Fluorescence filter blocks: B/G/V/BV
<b>Light distribution</b>	12V50W Halogen Lamp, C-HGFI HG Fiber Illuminator, LV-LL LED Lamphouse Eyepiece tube/Back port: 100/0, 55/45	
<b>Optics</b>	CFI60/CFI60-2 system	
<b>Observation image</b>	Surface Image	
<b>Observation method</b>	Bright/Darkfield/Simple Polarizing/DIC/Epi-Fluorescence	
<b>Revolving nosepieces</b>	LV-NU5I: Bright/Darkfield/DIC 5 position nosepiece, LV-NU5A: Motorized Bright/Darkfield/DIC 5 position nosepiece MA-N7-I Brightfield 7 position nosepiece (Intelligent)	
<b>Stage</b>	MA2-SR Mechanical Stage (X/Y flexible handle) Dimension: 295x215 mm, Stroke: 50 mmx50 mm (with distance graduation), Standard accessory: $\phi$ 22 universal specimen holder (with sample clip)	
<b>Trinocular eyepiece</b>	Siedentopf interpupillary distance adjustment 50-75 mm	
<b>Power source</b>	100-240 V, 50-60 Hz	
<b>Power consumption (max.)</b>	1.2 A 75 W	
<b>Weight</b>	Approx. 26 kg (depends on combination)	
<b>Options</b>	<b>Intermediate magnification</b>	Turret (1x, 1.5x, 2x), Status detection (Output magnification information to main unit)
	<b>Scale</b>	MA2-GR Grain Reticle (ASTM E112-63 grain sizing numbers 1 to 8), Grid Reticle(20 lines, 0.5 mm)
		MA2-MR Scale Reticle (compatible with 5-100x, Read in $\mu$ m, Dialing System)

## Specifications (MA100N)

MA100N	
<b>Optics</b>	CFI60/CFI60-2 system
<b>Observation image</b>	Reversed image
<b>Observation method</b>	Brightfield and polarization (with MA P/A simple polarizer/analyzer set)
<b>Focusing</b>	Focusing nosepiece (fixed stage), coaxial coarse/fine adjustment knob with 8.5-mm stroke (Coarse adjustment of 37.7 mm per rotation, fine adjustment of 0.2 mm per rotation)
<b>Nosepiece</b>	Brightfield 5-position nosepiece
<b>Stage</b>	MA-SR-N Rectangular 3-plate Stage N: 50x50 mm stroke (includes two stage inserts ( $\phi$ 20 mm and 40 mm opening) and coaxial control handle on the right side The 3-plate design allows entire top surface to move. Optional Stage inserts: MA-SRSH1 Specimen Holder 1 with ( $\phi$ 15 mm opening or MA-SH3 Specimen Holder 3 with 2 mm to 32 mm adjustable opening)
	MA-SP-N Plain Stage N: 188x310 mm - Includes two stage inserts (1) clear acrylic stage insert with $\phi$ 30 mm opening, (2) clear acrylic stage insert with crescent opening (width 30 mm) to allow clearance for rotation of high magnification objectives
	Optional stage inserts: MA-SRSH1 Specimen Holder 1 with 15 mm opening or MA-SH3 Specimen Holder 3 with 2 mm to 32 mm adjustable opening Accepts Attachable Mechanical Stage TI-SM
	TSS2-S-SM Mechanical Stage: 126 mmx78 mm stroke, handle can be attached on the right or left side of the plain stage
	Optional Specimen Holders to fit Attachable Mechanical stage: MA-SH1-N Specimen Holder 1N ( $\phi$ 15 mm opening)
	MA-SH2-N Specimen Holder 2N ( $\phi$ 30 mm opening), or C-S-HU Universal Holder (30 mm to 65 mm adjustable opening)
<b>Illuminator</b>	Internal power supply white LED light source, condenser built-in (lever operated)
<b>Binocular body</b>	Built-in Siedentopf binocular, 45 inclination angle and 50 to 75-mm interpupillary adjustment, attachable camera port, eyepiece/Port: 100/0:0/100
<b>Power consumption (max.)</b>	15W
<b>Weight</b>	Approx. 10 kg

Specifications and equipment are subject to change without any notice or obligation on the part of the manufacturer. June 2023 ©2006-2023 NIKON CORPORATION

N.B. Export of the products\* in this brochure is controlled under the Japanese Foreign Exchange and Foreign Trade Law. Appropriate export procedures shall be required in case of export from Japan.

\*Products: Hardware and its technical information (including software)



**WARNING**

TO ENSURE CORRECT USAGE, READ THE CORRESPONDING MANUALS CAREFULLY BEFORE USING THE EQUIPMENT.



### NIKON CORPORATION

1-5-20, Nishioi, Shinagawa-ku, Tokyo 140-8601 Japan  
<https://industry.nikon.com/>

ISO 14001 Certified  
for NIKON CORPORATION

ISO 9001 Certified  
for NIKON CORPORATION  
Industrial Metrology Business Unit

### NIKON METROLOGY EUROPE NV

Interleuvenlaan 86 B-3001 Leuven, Belgium  
 phone: +32-16-74-01-00 fax: +32-16-74-01-03  
 E-mail: [Sales.Europe.NM@nikon.com](mailto:Sales.Europe.NM@nikon.com)  
<https://industry.nikon.com/en-gb/>

### NIKON METROLOGY UK LTD.

UNITED KINGDOM phone: +44-1332-811-349 fax: +44-1332-639-881  
 E-mail: [Sales.UK.NM@nikon.com](mailto:Sales.UK.NM@nikon.com)

### NIKON METROLOGY SARL

FRANCE phone: +33-1-60-86-09-76 fax: +33-1-60-86-57-35  
 E-mail: [Sales.France.NM@nikon.com](mailto:Sales.France.NM@nikon.com)

### NIKON METROLOGY GMBH

GERMANY phone: +49-211-45-44-69-51  
 E-mail: [Sales.Germany.NM@nikon.com](mailto:Sales.Germany.NM@nikon.com)

### NIKON INSTRUMENTS S.p.A.

ITALY phone: +39-055-300-96-01 fax: +39-055-30-09-93

### NIKON METROLOGY, INC.

12701 Grand River Road, Brighton, MI 48116 U.S.A.  
 phone: +1-810-220-4360 fax: +1-810-220-4300  
 E-mail: [Sales.NM-US@nikon.com](mailto:Sales.NM-US@nikon.com)  
<https://industry.nikon.com/en-us/>

### NIKON METROLOGY - MÉXICO

E-mail: [Sales.NM-MX@nikon.com](mailto:Sales.NM-MX@nikon.com)

### NIKON PRECISION (SHANGHAI) CO., LTD.

CHINA (Shanghai branch) phone: +86-21-6841-2050 fax: +86-21-6841-2060  
 (Beijing branch) phone: +86-10-5831-2028 fax: +86-10-5831-2026  
 (Guangzhou branch) phone: +86-20-3882-0551 fax: +86-20-3882-0580

### NIKON INSTRUMENTS KOREA CO., LTD.

KOREA phone: +82-2-6288-1900 fax: +82-2-555-4415

### NIKON SINGAPORE PTE. LTD.

SINGAPORE phone: +65-6559-3651 fax: +65-6559-3668  
 E-mail: [NSG.Industrial-sales@nikon.com](mailto:NSG.Industrial-sales@nikon.com)

### PT. NIKON INDONESIA

INDONESIA phone: +62-267-864-3949 fax: +62-267-864-3950

E-mail: [PTN.Instruments@nikon.com](mailto:PTN.Instruments@nikon.com)

### NIKON SALES (THAILAND) CO., LTD.

THAILAND phone: +66-2633-5100 fax: +66-2633-5191